

# ALL-TERRAIN ATF 50G-3



Maße (mm)  
 Dimensions (mm)  
 Dimensiones (mm)

 385/95 R 25  
 (14.00 R 25)

DIN/ISO/EN

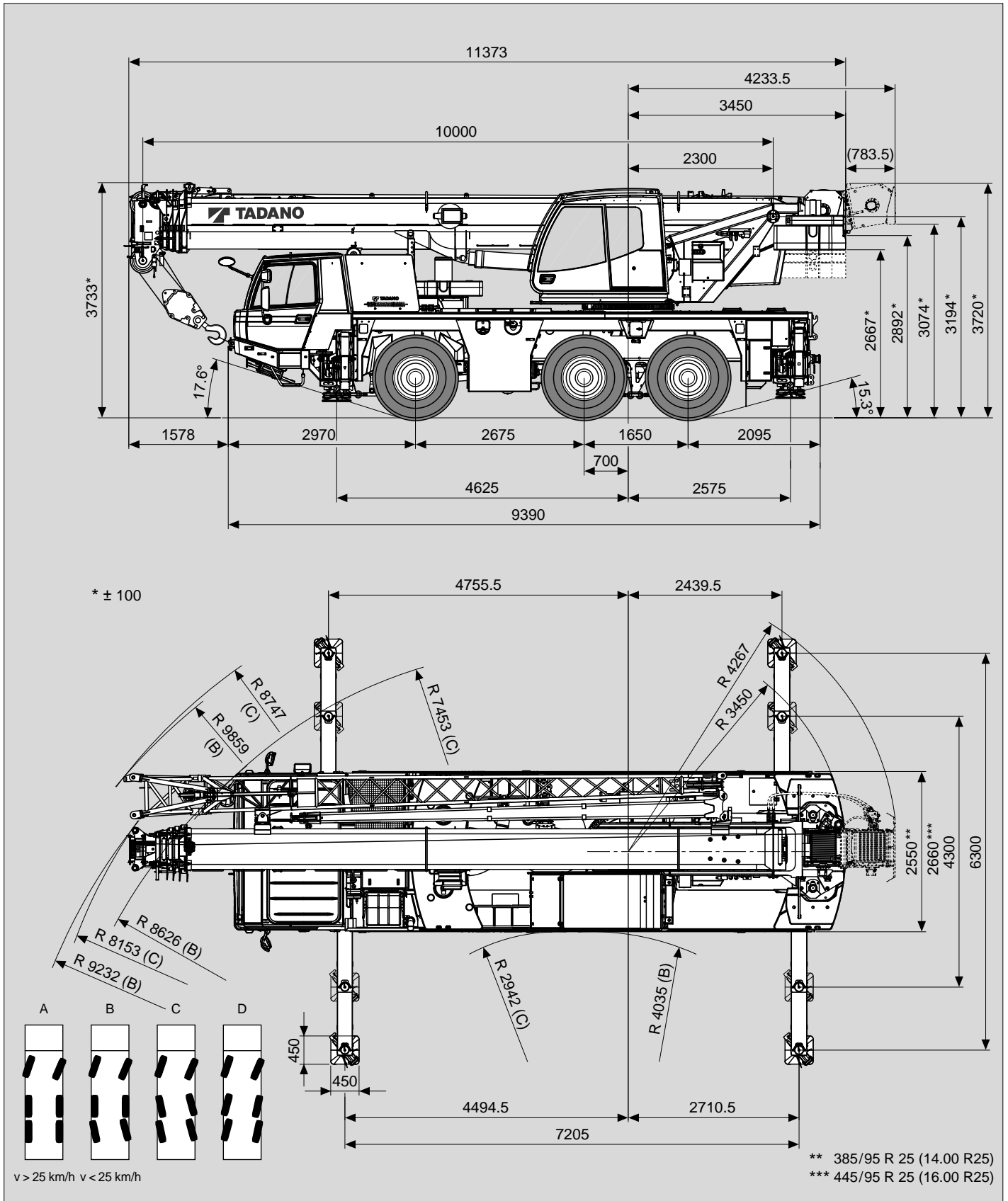

Gewichte / Geschwindigkeiten  
Weights / Working speeds  
Poids / Vitesses  
Pesos / Velocidades de trabajo

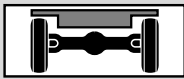
	<b>Achse / Axle Essieu / Eje</b>	1	2	3	<b>Gesamtgewicht / Total weight Poids total / Peso total</b>
	(t)	12	12	12	36*

\* Incl. 7,0 t Gegengewicht, 9 m / 16 m Auslegerverlängerung, 32 t Unterflasche, 6 t Hakengeschirr, Bereifung 445/95 R 25 (16.00 R 25).



\* Incl. 7.0 t counterweight, 9 m / 16 m boom extension, 32 t hook block, 6 t swivel hook, tyres 445/95 R 25 (16.00 R 25).



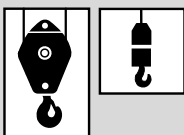

\* Incl. de 7,0 t contrepoids, 9 m / 16 m flèche, 32 t moufle, 6 t ellingues, pneus 445/95 R 25 (16.00 R 25).

\* Incl. contrapeso de 7,0 t, 9 m / 16 m plúmin, 32 t gancho, 6 t gancho de bola, neumáticos 445/95 R 25 (16.00 R 25).

 <p>* Doppelhaken * Rams horn * Moufle avec crochet marin * Gancho doble</p>	<b>Traglast / Lifting capacity / Force de levage / Capacidad de elevación</b>	<b>Rollen / Sheaves Pulies / Poleas</b>	<b>Stränge / Parts of line Brins / Ramales de cable</b>	<b>Gewicht / Weight Poid / Peso</b>
	50 t *	5	11	475 kg
	32 t	3	7	300 kg
	12.5 t	1	3	185 kg
	6 t	-	1	150 kg

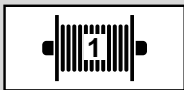

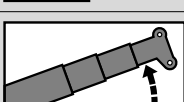
		1	2	3	4	5	6	7	8	9	10	11	12	R1	R2	
385/95 (14.00)	km/h	5	7	9	11	14	18	24	31	40	51	65	84	6	7	
445/95 (16.00)	km/h	6	7	10	12	16	20	26	34	44	56	71	85	6	8	59%

<b>V+</b> 	<b>Stufenlos Infinitely variable Progressivement variable Infinitamente variable</b>	<b>Seil Rope Câble Cable</b>	<b>Max. Seilzug Max. single line pull Effort maxi au brin simple Trio máximo por ramal</b>
	0 - 120 m/min für einfachen Strang single line au brin simple ramal simple	16 mm / 170 m	44 kN
	0 - 60 m/min für einfachen Strang single line au brin simple ramal simple	16 mm / 170 m	44 kN
	0 - 1.9 min <sup>-1</sup>		
	-2° - +83° ca. 40 s approx. 40 s env. 40 s aproximadamente 40 s		
	10.0 m - 40.0 m ca. 100 s approx. 100 s env. 100 s aproximadamente 100 s		

Tragfähigkeiten  
Lifting capacities  
Capacités de levage  
Capacidades de elevación

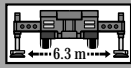
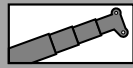

10t

DIN/ISO/EN

m	10.0 m*	10.0 m	13.8 m	17.5 m	21.3 m	25.0 m	28.8 m	32.5 m	36.3 m	40.0 m
2.5	50.0**									
3.0	45.4**	45.4**	30.0	30.0	20.0					
3.5	41.6	41.6	30.0	30.0	20.0	20.0				
4.0	38.4	38.4	30.0	30.0	20.0	20.0	17.6			
4.5	35.5	35.1	30.0	28.7	20.0	20.0	17.6			
5.0	32.8	31.8	30.0	26.9	20.0	20.0	17.2	12.8		
6.0	26.9	26.6	26.1	23.8	20.0	18.2	15.6	12.8	9.9	
7.0	22.3	22.3	21.7	21.3	18.9	16.5	14.3	12.4	9.9	7.5
8.0			19.1	19.5	17.5	15.1	13.1	11.5	9.9	7.5
9.0			15.7	16.0	16.1	13.8	12.1	10.6	9.5	7.5
10.0			13.2	13.5	13.7	12.4	11.2	9.9	8.8	7.5
11.0			11.3	11.6	11.7	10.6	10.4	9.2	8.2	7.3
12.0				10.1	10.2	9.1	9.3	8.6	7.7	6.9
14.0				7.8	8.0	8.1	7.1	7.3	6.8	6.1
16.0					6.4	6.5	6.2	5.8	5.9	5.4
18.0					5.3	5.4	5.4	4.8	4.8	4.9
20.0						4.5	4.5	4.3	3.9	4.0
22.0						3.8	3.8	3.8	3.2	3.3
24.0							3.3	3.3	2.6	2.7
26.0							2.8	2.8	2.1	2.3
28.0								2.4	1.7	1.8
30.0								2.1	1.4	1.5
32.0									1.1	1.2
34.0										1.0
36.0										0.7
38.0										

\* Nach hinten / \* Over rear / \* A l'arrière / \* Sobre la parte trasera

\*\* Mit Zusatzhubausrüstungen / \*\* With additional lifting equipments / \*\* Avec équipements supplémentaires / \*\* Con equipos adicionales

Hubhöhen  
Lifting heights  
Hauteurs de levage  
Alturas de elevación

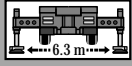
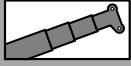

10t

DIN/ISO/EN

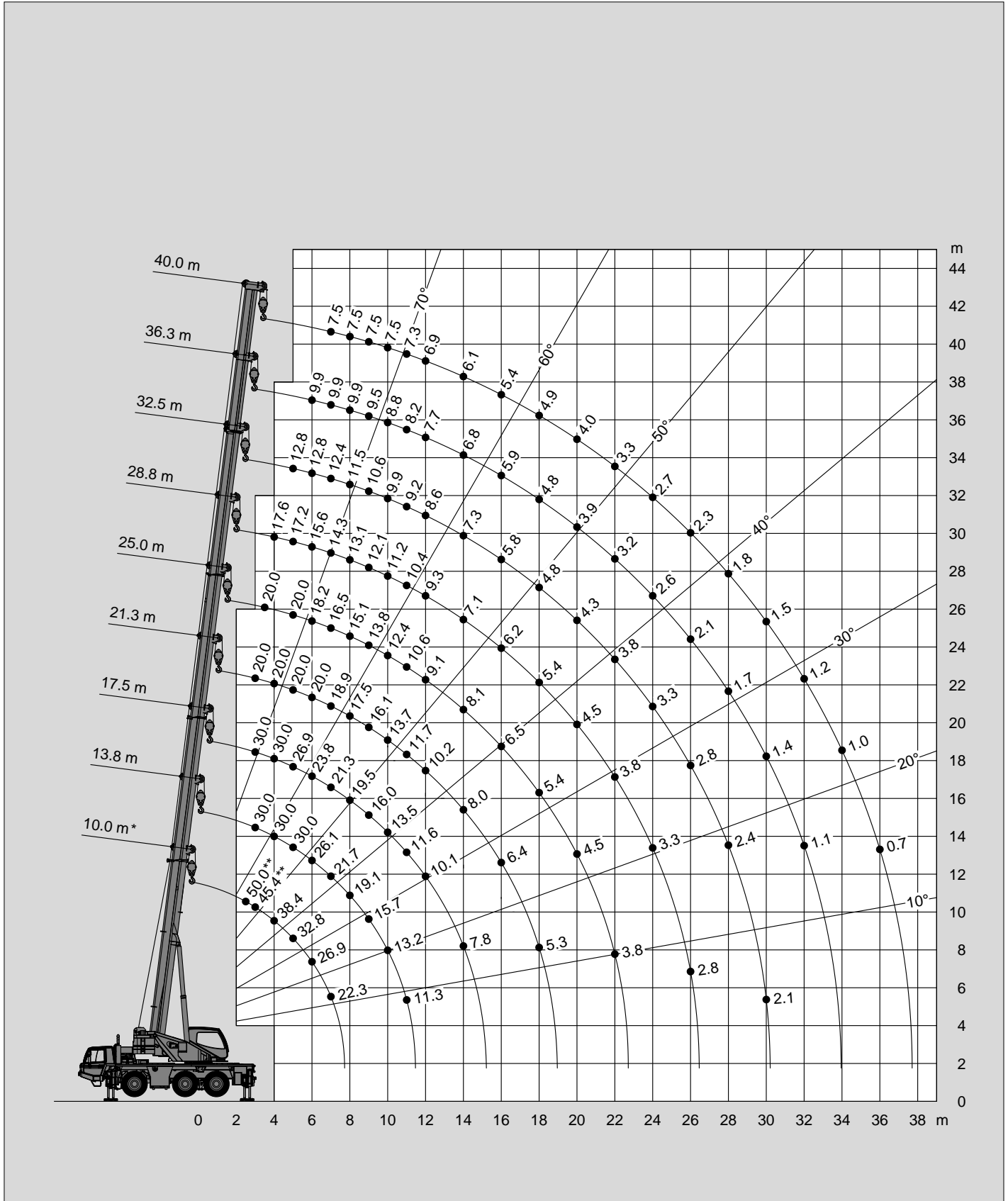

\* Nach hinten / \* Over rear / \* A l'arrière / \* Sobre la parte trasera

\*\* Mit Zusatzhubausrüstungen / \*\* With additional lifting equipments / \*\* Avec équipements supplémentaires / \*\* Con equipos adicionales

Tragfähigkeiten  
Lifting capacities  
Capacités de levage  
Capacidades de elevación

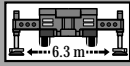
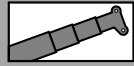

7t

DIN/ISO/EN

↙ m	10.0 m*	10.0 m	13.8 m	17.5 m	21.3 m	25.0 m	28.8 m	32.5 m	36.3 m	40.0 m
2.5	50.0**									
3.0	45.4**	45.4**	30.0	30.0	20.0					
3.5	41.6	41.6	30.0	30.0	20.0	20.0				
4.0	38.4	37.9	30.0	30.0	20.0	20.0	17.6			
4.5	35.5	34.0	30.0	28.7	20.0	20.0	17.6			
5.0	31.9	30.8	30.0	26.9	20.0	20.0	17.2	12.8		
6.0	25.5	25.4	24.9	23.5	20.0	18.2	15.6	12.8	9.9	
7.0	20.6	20.4	20.0	20.0	18.9	16.5	14.3	12.4	9.9	7.5
8.0			16.8	17.1	17.1	14.9	13.1	11.5	9.9	7.5
9.0			13.7	14.0	14.2	12.7	12.1	10.6	9.5	7.5
10.0			11.5	11.8	12.0	10.7	10.8	9.9	8.8	7.5
11.0			9.8	10.1	10.2	9.8	9.3	9.2	8.2	7.3
12.0				8.7	8.9	9.0	8.0	8.2	7.7	6.9
14.0				6.7	6.9	7.0	7.0	6.2	6.4	6.1
16.0					5.5	5.6	5.7	5.5	5.0	5.1
18.0					4.4	4.5	4.6	4.7	3.9	4.1
20.0						3.7	3.8	3.8	3.1	3.2
22.0						3.1	3.1	3.2	2.5	2.6
24.0							2.6	2.7	1.9	2.1
26.0							2.2	2.2	1.5	1.6
28.0								1.9	1.2	1.3
30.0								1.6	0.9	1.0
32.0									0.6	0.7
34.0										0.5
36.0										

\* Nach hinten / \* Over rear / \* A l'arrière / \* Sobre la parte trasera

\*\* Mit Zusatzhubausrüstungen / \*\* With additional lifting equipments / \*\* Avec équipements supplémentaires / \*\* Con equipos adicionales

Hubhöhen  
Lifting heights  
Hauteurs de levage  
Alturas de elevación

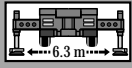
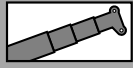

DIN/ISO/EN

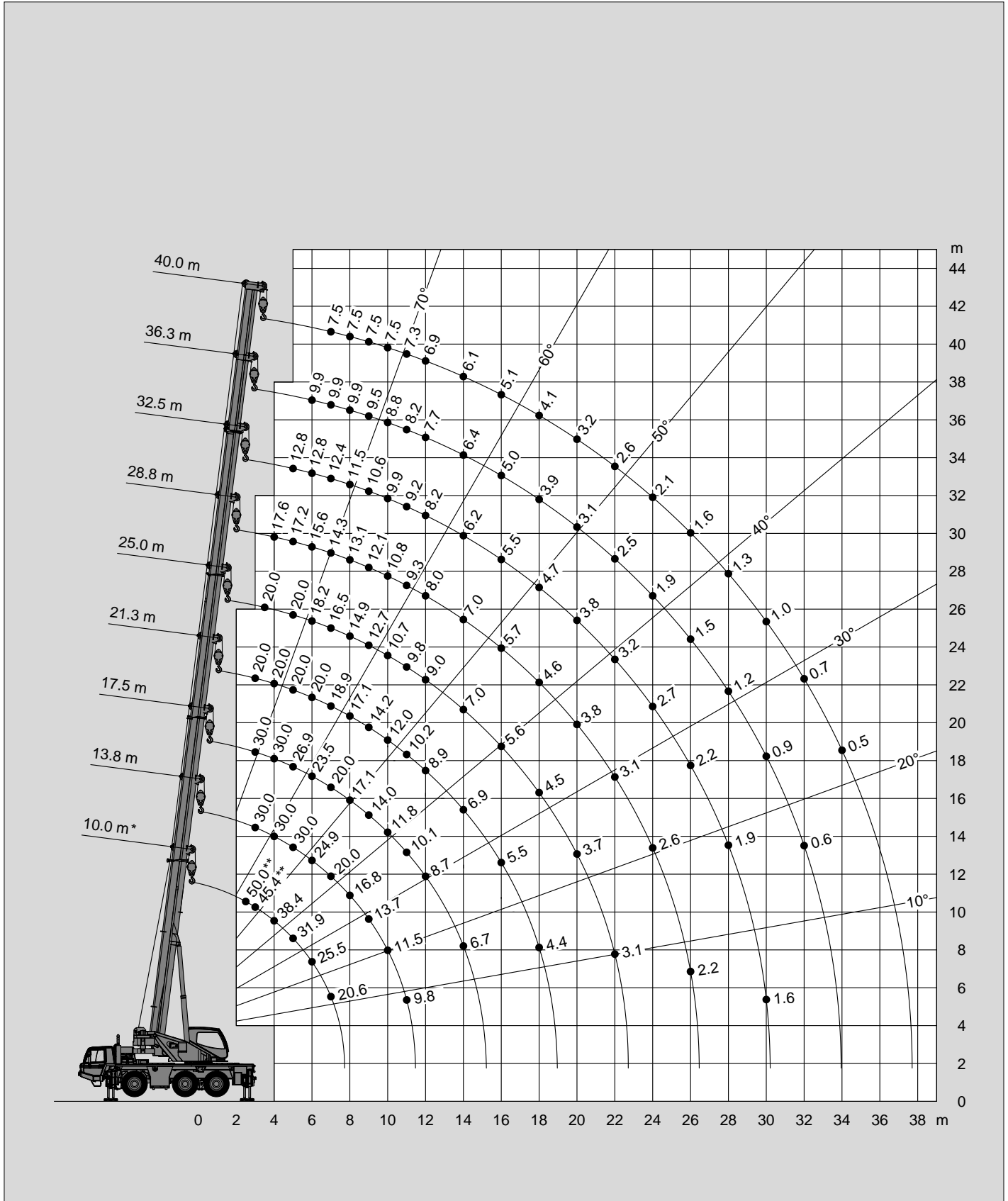

\* Nach hinten / \* Over rear / \* A l'arrière / \* Sobre la parte trasera

\*\* Mit Zusatzhubausrüstungen / \*\* With additional lifting equipments / \*\* Avec équipements supplémentaires / \*\* Con equipos adicionales

Tragfähigkeiten  
Lifting capacities  
Capacités de levage  
Capacidades de elevación

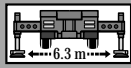
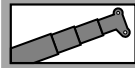

4.9t

DIN/ISO/EN

 m	10.0 m*	10.0 m	13.8 m	17.5 m	21.3 m	25.0 m	28.8 m	32.5 m	36.3 m	40.0 m
2.5	50.0**									
3.0	45.4**	45.4**	30.0	30.0	20.0					
3.5	41.6	41.6	30.0	30.0	20.0	20.0				
4.0	38.4	36.9	30.0	30.0	20.0	20.0	17.6			
4.5	34.5	33.1	30.0	28.7	20.0	20.0	17.6			
5.0	30.3	29.9	29.4	26.9	20.0	20.0	17.2	12.8		
6.0	24.2	24.1	23.0	20.6	20.0	18.2	15.6	12.8	9.9	
7.0	18.1	17.9	18.7	18.9	18.1	15.6	14.3	12.4	9.9	7.5
8.0			14.7	15.1	15.2	13.0	12.7	11.5	9.9	7.5
9.0			12.0	12.3	12.5	11.3	10.9	10.6	9.5	7.5
10.0			10.0	10.3	10.5	10.5	9.4	9.2	8.8	7.5
11.0			8.5	8.8	8.9	9.1	8.5	8.1	8.0	7.3
12.0				7.5	7.7	7.8	7.9	7.0	7.0	6.9
14.0				5.7	5.8	6.0	6.0	6.1	5.3	5.5
16.0					4.5	4.7	4.7	4.8	4.0	4.2
18.0					3.6	3.7	3.8	3.8	3.1	3.2
20.0						3.0	3.0	3.1	2.4	2.5
22.0						2.4	2.5	2.5	1.8	1.9
24.0							2.0	2.1	1.4	1.5
26.0							1.6	1.7	1.0	1.1
28.0								1.4	0.7	0.8
30.0								1.1		0.5
32.0										

\* Nach hinten / \* Over rear / \* A l'arrière / \* Sobre la parte trasera

\*\* Mit Zusatzhubausrüstungen / \*\* With additional lifting equipments / \*\* Avec équipements supplémentaires / \*\* Con equipos adicionales



Hubhöhen  
Lifting heights  
Hauteurs de levage  
Alturas de elevación

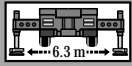
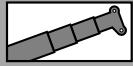

4.9t

DIN/ISO/EN

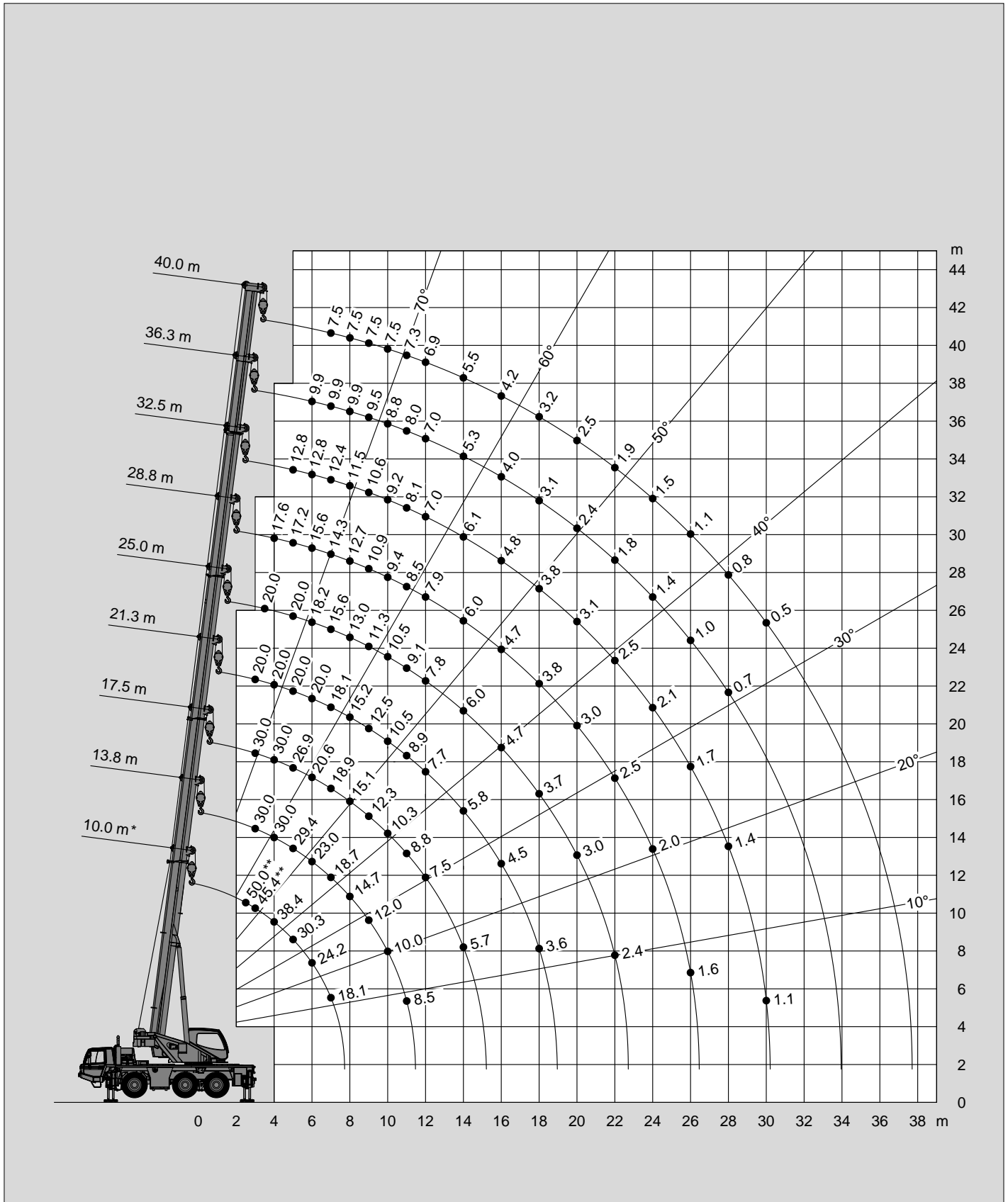

\* Nach hinten / \* Over rear / \* A l'arrière / \* Sobre la parte trasera

\*\* Mit Zusatzhubausrüstungen / \*\* With additional lifting equipments / \*\* Avec équipements supplémentaires / \*\* Con equipos adicionales

Tragfähigkeiten  
Lifting capacities  
Capacités de levage  
Capacidades de elevación

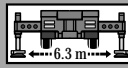
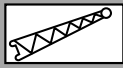
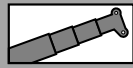

10t

DIN/ISO/EN

m	10.0 m + 9.0 m			28.8 m + 9.0 m			32.5 m + 9.0 m			36.3 m + 9.0 m			40.0 m + 9.0 m		
	0°	20°	40°	0°	20°	40°	0°	20°	40°	0°	20°	40°	0°	20°	40°
3.0	8.8														
3.5	8.8														
4.0	8.8	6.4													
4.5	8.6	6.1													
5.0	8.1	5.9													
6.0	7.2	5.4		7.1			5.8								
7.0	6.5	5.0	4.2	7.1			5.8								
8.0	5.9	4.7	3.9	7.1			5.8			4.3					
9.0	5.4	4.4	3.8	7.1	5.6		5.8			4.3			3.7		
10.0	5.0	4.1	3.6	6.9	5.5		5.8	5.3		4.3			3.7		
11.0	4.6	3.9	3.5	6.6	5.3	4.1	5.7	5.1		4.3	4.3		3.7		
12.0	4.3	3.7	3.4	6.3	5.1	4.0	5.4	4.9	4.0	4.3	4.3		3.7	3.7	
14.0	3.7	3.4	3.2	5.7	4.7	3.8	5.0	4.6	3.8	4.3	4.0	3.7	3.7	3.5	3.4
16.0	3.2	3.1		5.1	4.4	3.6	4.5	4.3	3.7	4.0	3.7	3.5	3.5	3.3	3.2
18.0				4.6	4.2	3.5	4.1	4.0	3.6	3.6	3.5	3.3	3.2	3.1	3.0
20.0				3.8	4.0	3.4	3.7	3.7	3.5	3.3	3.2	3.1	2.9	2.9	2.8
22.0				3.2	3.4	3.3	3.1	3.4	3.4	3.0	3.0	3.0	2.7	2.7	2.6
24.0				2.9	2.9	2.9	2.5	2.8	3.0	2.6	2.8	2.8	2.4	2.5	2.5
26.0				2.6	2.6	2.6	2.3	2.3	2.4	2.2	2.4	2.6	2.2	2.3	2.3
28.0				2.3	2.4	2.4	2.1	2.1	2.1	1.7	2.0	2.1	1.8	2.0	2.1
30.0				2.0	2.1		1.9	1.9	1.9	1.4	1.6	1.7	1.4	1.6	1.7
32.0				1.7	1.8		1.6	1.7	1.8	1.1	1.2	1.3	1.1	1.3	1.4
34.0				1.4			1.4	1.5		0.8	1.0	1.0	0.8	1.0	1.1
36.0							1.2	1.2		0.6	0.7		0.6	0.7	0.8
38.0							1.0				0.5			0.5	

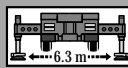
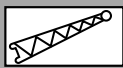
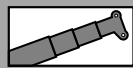

10t

DIN/ISO/EN

m	10.0 m + 16.0 m			28.8 m + 16.0 m			32.5 m + 16.0 m			36.3 m + 16.0 m			40.0 m + 16.0 m		
	0°	20°	40°	0°	20°	40°	0°	20°	40°	0°	20°	40°	0°	20°	40°
3.0	4.4														
3.5	4.4														
4.0	4.4														
4.5	4.4														
5.0	4.4														
6.0	4.3														
7.0	4.0			3.5											
8.0	3.7			3.5			3.0								
9.0	3.5	2.8		3.5			3.0			2.7					
10.0	3.3	2.7		3.5			3.0			2.7			2.3		
11.0	3.1	2.6		3.4			3.0			2.7			2.3		
12.0	2.9	2.4		3.3			3.0			2.7			2.3		
14.0	2.6	2.2	1.9	3.1	2.4		3.0	2.4		2.7			2.3		
16.0	2.3	2.0	1.8	2.9	2.3		2.9	2.3		2.7	2.2		2.3	2.1	
18.0	2.0	1.8	1.6	2.8	2.2	1.9	2.7	2.2	1.9	2.6	2.1		2.3	2.1	
20.0	1.8	1.6	1.5	2.6	2.1	1.8	2.6	2.1	1.8	2.5	2.0	1.8	2.3	2.0	
22.0	1.6	1.5		2.5	2.0	1.7	2.5	2.0	1.7	2.4	2.0	1.7	2.3	1.9	1.7
24.0				2.3	1.9	1.7	2.3	1.9	1.7	2.3	1.9	1.7	2.1	1.9	1.7
26.0				2.2	1.8	1.6	2.2	1.8	1.6	2.2	1.8	1.6	2.0	1.8	1.6
28.0				2.1	1.8	1.6	2.0	1.8	1.6	2.0	1.8	1.6	1.9	1.7	1.6
30.0				2.0	1.7	1.5	1.7	1.7	1.6	1.6	1.7	1.5	1.6	1.7	1.5
32.0				1.8	1.6	1.5	1.5	1.6	1.5	1.3	1.6	1.5	1.3	1.6	1.5
34.0				1.7	1.6	1.5	1.4	1.5	1.5	1.0	1.3	1.5	1.0	1.3	1.5
36.0				1.4	1.5	1.4	1.3	1.3	1.4	0.8	1.1	1.2	0.8	1.1	1.3
38.0				1.2	1.3		1.1	1.2	1.2	0.6	0.8	1.0	0.6	0.8	1.0
40.0				1.0	1.1		1.0	1.1			0.6	0.7		0.6	0.8
42.0				0.9			0.8	0.9							0.5
44.0							0.6	0.7							
46.0							0.5								

Hubhöhen  
Lifting heights  
Hauteurs de levage  
Alturas de elevación

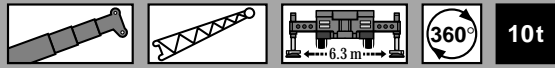

DIN/ISO/EN

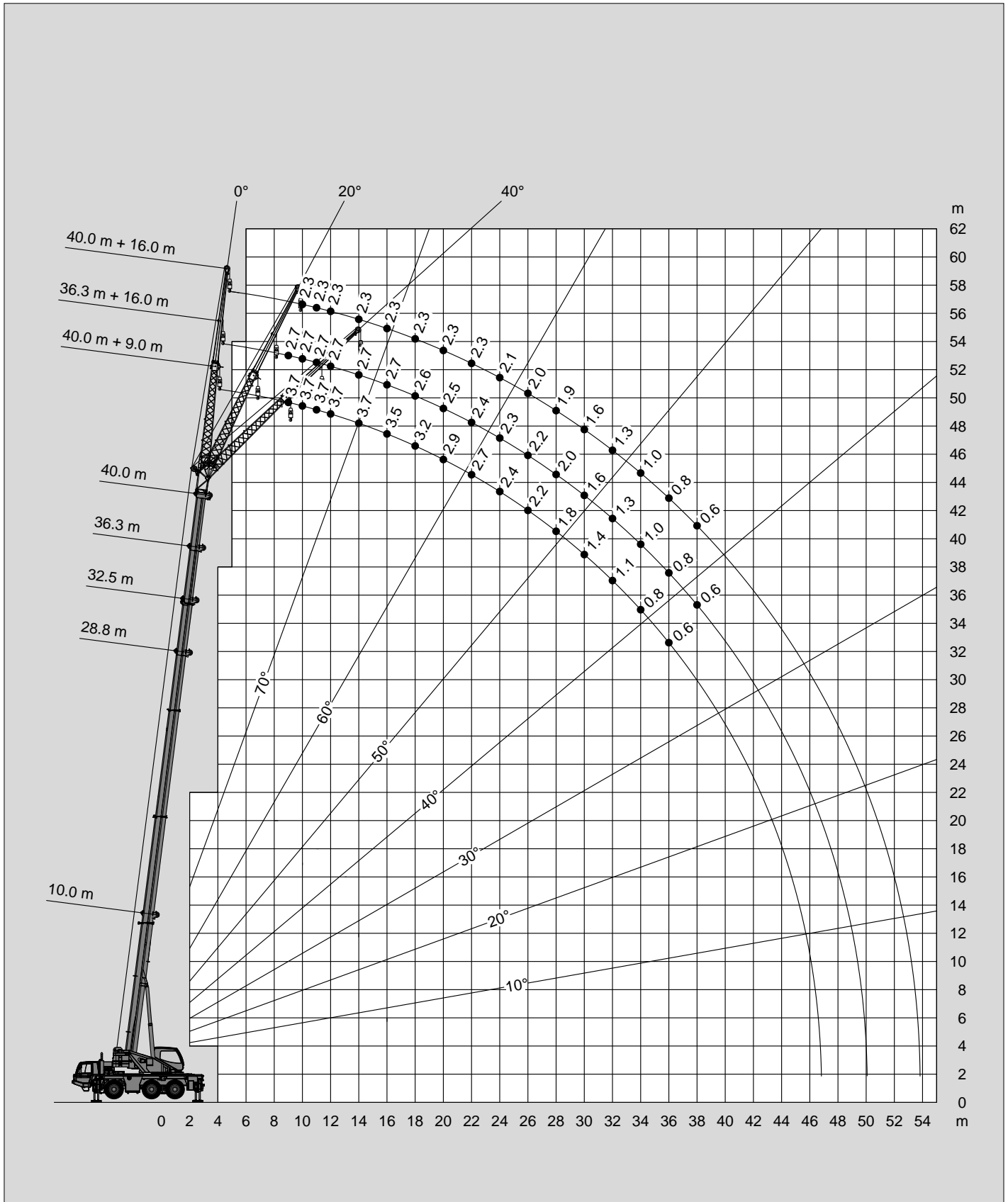

Tragfähigkeiten  
Lifting capacities  
Capacités de levage  
Capacidades de elevación



m	10.0 m + 9.0 m			28.8 m + 9.0 m			32.5 m + 9.0 m			36.3 m + 9.0 m			40.0 m + 9.0 m		
	0°	20°	40°	0°	20°	40°	0°	20°	40°	0°	20°	40°	0°	20°	40°
3.0	8.8														
3.5	8.8														
4.0	8.8	6.4													
4.5	8.6	6.1													
5.0	8.1	5.9													
6.0	7.2	5.4		7.1			5.8								
7.0	6.5	5.0	4.2	7.1			5.8								
8.0	5.9	4.7	3.9	7.1			5.8			4.3					
9.0	5.4	4.4	3.8	7.1	5.6		5.8			4.3			3.7		
10.0	5.0	4.1	3.6	6.9	5.5		5.8	5.3		4.3			3.7		
11.0	4.6	3.9	3.5	6.6	5.3	4.1	5.7	5.1		4.3	4.3		3.7		
12.0	4.3	3.7	3.4	6.3	5.1	4.0	5.4	4.9	4.0	4.3	4.3		3.7	3.7	
14.0	3.7	3.4	3.2	5.7	4.7	3.8	5.0	4.6	3.8	4.3	4.0	3.7	3.7	3.5	3.4
16.0	3.2	3.1		4.9	4.4	3.6	4.5	4.3	3.7	4.0	3.7	3.5	3.5	3.3	3.2
18.0				3.8	4.2	3.5	3.9	4.0	3.6	3.6	3.5	3.3	3.2	3.1	3.0
20.0				3.5	3.4	3.4	3.0	3.4	3.5	3.2	3.2	3.1	2.9	2.9	2.8
22.0				3.1	3.2	3.1	2.8	2.8	3.0	2.5	2.8	3.0	2.5	2.7	2.6
24.0				2.6	2.8	2.9	2.5	2.5	2.6	2.0	2.3	2.5	2.0	2.3	2.5
26.0				2.1	2.3	2.4	2.1	2.3	2.3	1.5	1.8	2.0	1.6	1.8	2.0
28.0				1.8	1.9	2.0	1.7	1.9	2.0	1.2	1.4	1.5	1.2	1.4	1.6
30.0				1.5	1.6		1.4	1.6	1.6	0.9	1.1	1.2	0.9	1.1	1.2
32.0				1.2	1.3		1.2	1.3	1.3	0.6	0.8	0.9	0.6	0.8	0.9
34.0				1.0			0.9	1.0			0.5	0.6		0.5	0.6
36.0							0.7	0.8							
38.0							0.6								



m	10.0 m + 16.0 m			28.8 m + 16.0 m			32.5 m + 16.0 m			36.3 m + 16.0 m			40.0 m + 16.0 m		
	0°	20°	40°	0°	20°	40°	0°	20°	40°	0°	20°	40°	0°	20°	40°
3.0	4.4														
3.5	4.4														
4.0	4.4														
4.5	4.4														
5.0	4.4														
6.0	4.3														
7.0	4.0			3.5											
8.0	3.7			3.5			3.0								
9.0	3.5	2.8		3.5			3.0			2.7					
10.0	3.3	2.7		3.5			3.0			2.7			2.3		
11.0	3.1	2.6		3.4			3.0			2.7			2.3		
12.0	2.9	2.4		3.3			3.0			2.7			2.3		
14.0	2.6	2.2	1.9	3.1	2.4		3.0	2.4		2.7			2.3		
16.0	2.3	2.0	1.8	2.9	2.3		2.9	2.3		2.7	2.2		2.3	2.1	
18.0	2.0	1.8	1.6	2.8	2.2	1.9	2.7	2.2	1.9	2.6	2.1		2.3	2.1	
20.0	1.8	1.6	1.5	2.6	2.1	1.8	2.6	2.1	1.8	2.5	2.0	1.8	2.3	2.0	
22.0	1.6	1.5		2.5	2.0	1.7	2.5	2.0	1.7	2.4	2.0	1.7	2.3	1.9	1.7
24.0				2.3	1.9	1.7	2.2	1.9	1.7	2.2	1.9	1.7	2.1	1.9	1.7
26.0				2.2	1.8	1.6	2.0	1.8	1.6	1.8	1.8	1.6	1.8	1.8	1.6
28.0				2.0	1.8	1.6	1.9	1.8	1.6	1.4	1.8	1.6	1.4	1.7	1.6
30.0				1.7	1.7	1.5	1.6	1.7	1.6	1.1	1.5	1.5	1.1	1.4	1.5
32.0				1.4	1.6	1.5	1.4	1.6	1.5	0.8	1.1	1.4	0.8	1.1	1.4
34.0				1.2	1.4	1.5	1.1	1.3	1.5	0.6	0.9	1.1	0.6	0.9	1.1
36.0				1.0	1.1	1.2	0.9	1.1	1.2		0.6	0.8		0.6	0.8
38.0				0.8	0.9		0.7	0.9	1.0			0.6			0.6
40.0				0.6	0.7		0.6	0.7							
42.0				0.5			0.5								

Hubhöhen  
Lifting heights  
Hauteurs de levage  
Alturas de elevación

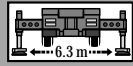
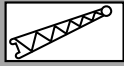
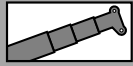

7t

DIN/ISO/EN

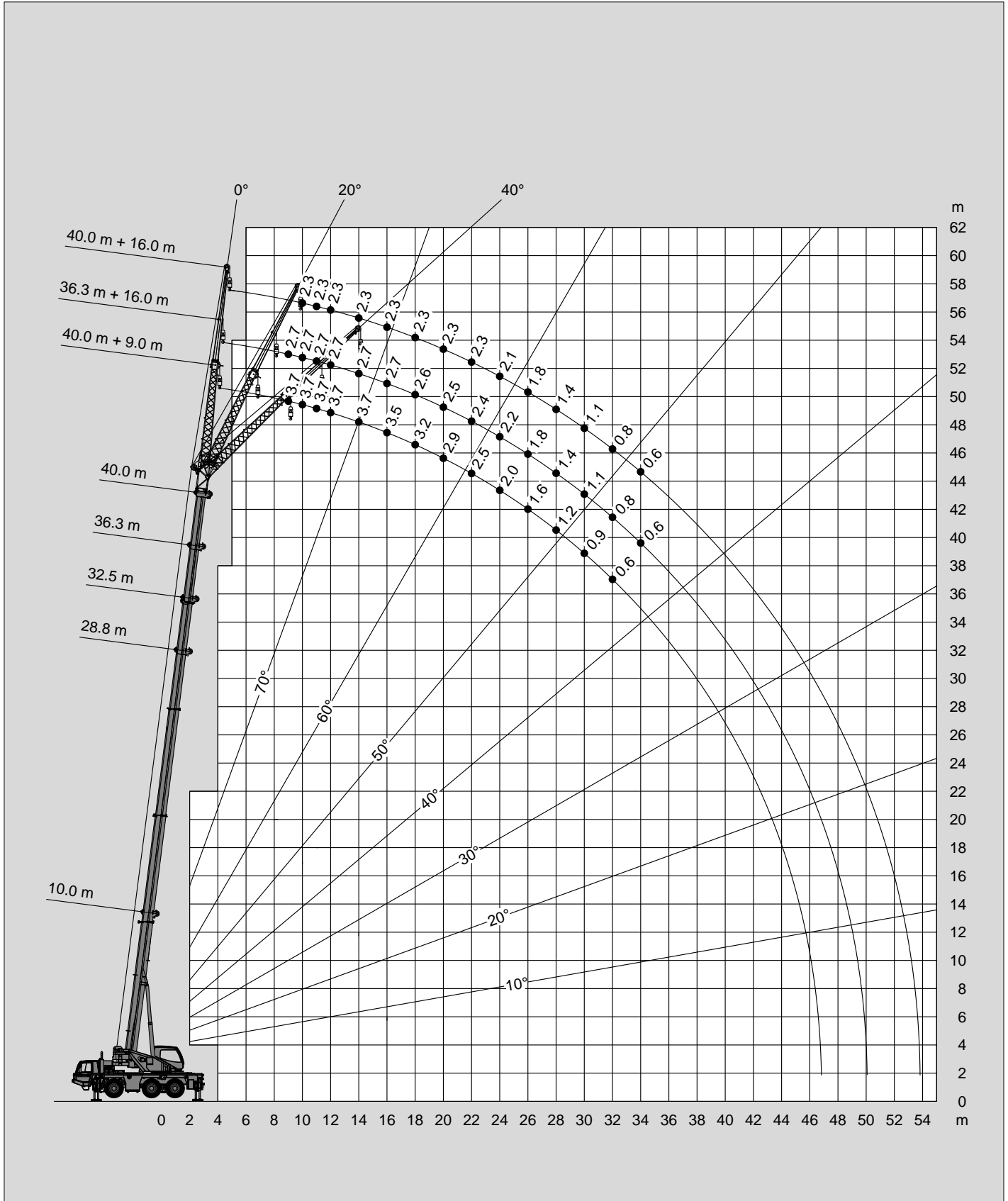

Tragfähigkeiten  
Lifting capacities  
Capacités de levage  
Capacidades de elevación



m	10.0 m + 9.0 m			28.8 m + 9.0 m			32.5 m + 9.0 m			36.3 m + 9.0 m			40.0 m + 9.0 m		
	0°	20°	40°	0°	20°	40°	0°	20°	40°	0°	20°	40°	0°	20°	40°
3.0	8.8														
3.5	8.8														
4.0	8.8	6.4													
4.5	8.6	6.1													
5.0	8.1	5.9													
6.0	7.2	5.4		7.1			5.8								
7.0	6.5	5.0	4.2	7.1			5.8								
8.0	5.9	4.7	3.9	7.1			5.8			4.3					
9.0	5.4	4.4	3.8	7.1	5.6		5.8			4.3			3.7		
10.0	5.0	4.1	3.6	6.9	5.5		5.8	5.3		4.3			3.7		
11.0	4.6	3.9	3.5	6.6	5.3	4.1	5.7	5.1		4.3	4.3		3.7		
12.0	4.3	3.7	3.4	6.3	5.1	4.0	5.4	4.9	4.0	4.3	4.3		3.7	3.7	
14.0	3.7	3.4	3.2	5.4	4.7	3.8	5.0	4.6	3.8	4.3	4.0	3.7	3.7	3.5	3.4
16.0	3.2	3.1		4.2	4.4	3.6	4.0	4.3	3.7	4.0	3.7	3.5	3.5	3.3	3.2
18.0				3.8	3.7	3.5	3.4	3.5	3.6	3.2	3.5	3.3	3.2	3.1	3.0
20.0				3.2	3.4	3.3	3.0	3.0	3.0	2.4	2.8	3.1	2.5	2.8	2.8
22.0				2.6	2.8	3.0	2.5	2.8	2.8	1.9	2.2	2.4	1.9	2.2	2.5
24.0				2.1	2.3	2.4	2.0	2.3	2.4	1.4	1.7	1.9	1.4	1.7	1.9
26.0				1.7	1.9	2.0	1.6	1.8	2.0	1.0	1.3	1.4	1.0	1.3	1.5
28.0				1.4	1.5	1.6	1.3	1.5	1.6	0.7	0.9	1.1	0.7	0.9	1.1
30.0				1.1	1.2		1.0	1.2	1.3		0.6	0.7		0.6	0.8
32.0				0.8	0.9		0.8	0.9	1.0						0.5
34.0				0.6			0.6	0.7							
36.0								0.5							



m	10.0 m + 16.0 m			28.8 m + 16.0 m			32.5 m + 16.0 m			36.3 m + 16.0 m			40.0 m + 16.0 m		
	0°	20°	40°	0°	20°	40°	0°	20°	40°	0°	20°	40°	0°	20°	40°
3.0	4.4														
3.5	4.4														
4.0	4.4														
4.5	4.4														
5.0	4.4														
6.0	4.3														
7.0	4.0			3.5											
8.0	3.7			3.5			3.0								
9.0	3.5	2.8		3.5			3.0			2.7					
10.0	3.3	2.7		3.5			3.0			2.7			2.3		
11.0	3.1	2.6		3.4			3.0			2.7			2.3		
12.0	2.9	2.4		3.3			3.0			2.7			2.3		
14.0	2.6	2.2	1.9	3.1	2.4		3.0	2.4		2.7			2.3		
16.0	2.3	2.0	1.8	2.9	2.3		2.9	2.3		2.7	2.2		2.3	2.1	
18.0	2.0	1.8	1.6	2.8	2.2	1.9	2.7	2.2	1.9	2.6	2.1		2.3	2.1	
20.0	1.8	1.6	1.5	2.6	2.1	1.8	2.6	2.1	1.8	2.5	2.0	1.8	2.3	2.0	
22.0	1.6	1.5		2.4	2.0	1.7	2.4	2.0	1.7	2.1	2.0	1.7	2.1	1.9	1.7
24.0				2.3	1.9	1.7	2.2	1.9	1.7	1.6	1.9	1.7	1.6	1.9	1.7
26.0				2.0	1.8	1.6	1.9	1.8	1.6	1.2	1.7	1.6	1.2	1.7	1.6
28.0				1.6	1.7	1.6	1.6	1.7	1.6	0.9	1.3	1.6	0.9	1.3	1.6
30.0				1.3	1.6	1.5	1.3	1.5	1.5	0.6	1.0	1.3	0.6	1.0	1.3
32.0				1.1	1.3	1.5	1.0	1.3	1.4		0.7	1.0		0.7	1.0
34.0				0.9	1.0	1.2	0.8	1.0	1.2		0.5	0.7		0.5	0.7
36.0				0.7	0.8	0.9	0.6	0.8	0.9						0.5
38.0				0.5	0.6			0.6	0.7						

Hubhöhen  
Lifting heights  
Hauteurs de levage  
Alturas de elevación

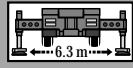
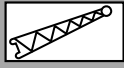
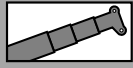

4.9t

DIN/ISO/EN

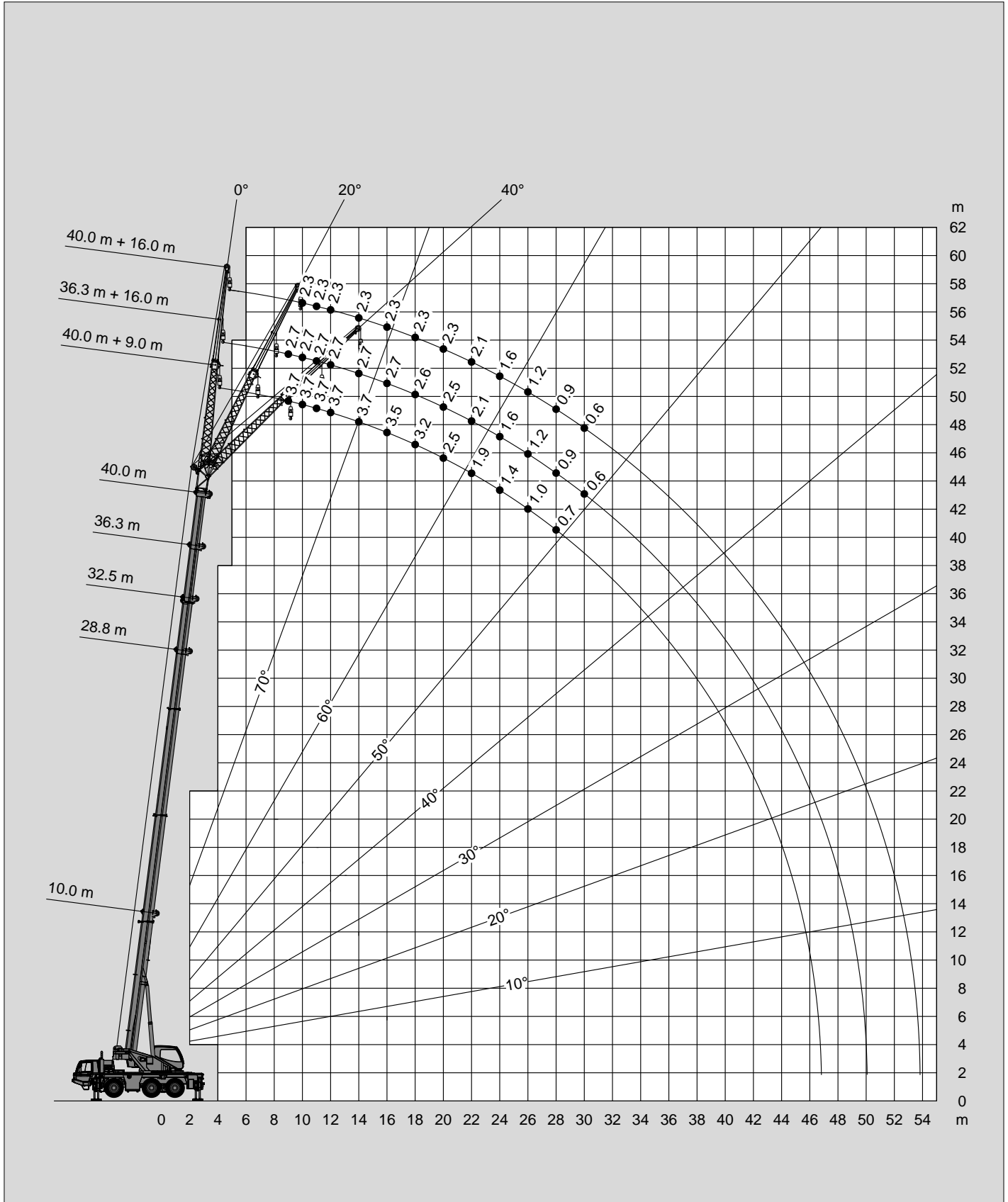

Tragfähigkeiten  
Lifting capacities  
Capacités de levage  
Capacidades de elevación

Hubhöhen  
Lifting heights  
Hauteurs de levage  
Alturas de elevación



↘ m	10.0 m*	13.8 m*	17.5 m*
3.0	11.6	11.9	12.0
3.5	10.3	10.5	10.7
4.0	8.8	9.0	9.3
4.5	7.7	8.0	8.1
5.0	6.5	6.8	7.0
6.0	4.9	5.2	5.4
7.0	3.9	4.2	4.3
8.0		3.4	3.6
9.0		2.9	3.0
10.0		2.4	2.6
11.0		2.1	2.3
12.0			1.9
14.0			1.5
16.0			

\* Oberwagenverriegelung eingelegt \* Superstructure verrouillé  
\* Superstructure locked \* Bloqueo de superestructura

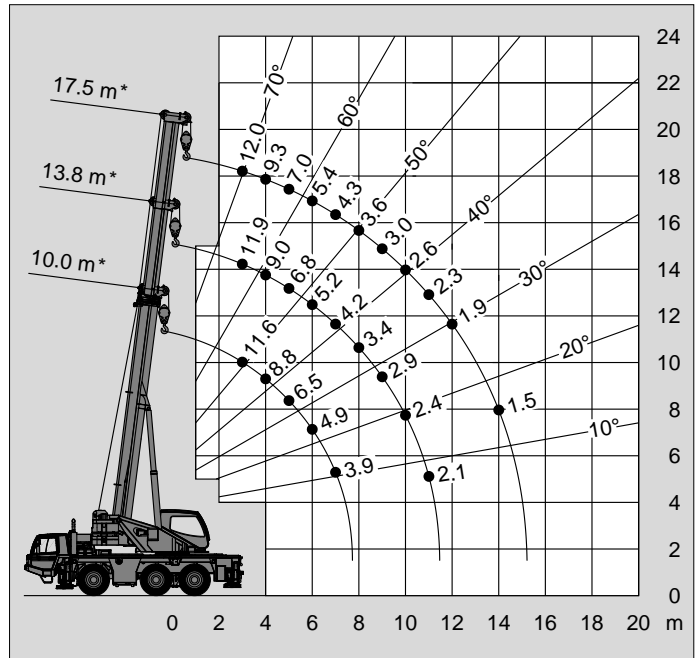

↘ m	10.0 m*	13.8 m*	17.5 m*
3.0	9.1	9.5	9.7
3.5	7.6	7.9	8.1
4.0	6.5	6.7	6.9
4.5	5.5	5.8	6.0
5.0	4.8	5.0	5.2
6.0	3.7	4.0	4.2
7.0	3.0	3.2	3.4
8.0		2.6	2.8
9.0		2.2	2.4
10.0		1.9	2.0
11.0		1.6	1.7
12.0			1.5
14.0			1.2
16.0			

\* Oberwagenverriegelung eingelegt \* Superstructure verrouillé  
\* Superstructure locked \* Bloqueo de superestructura

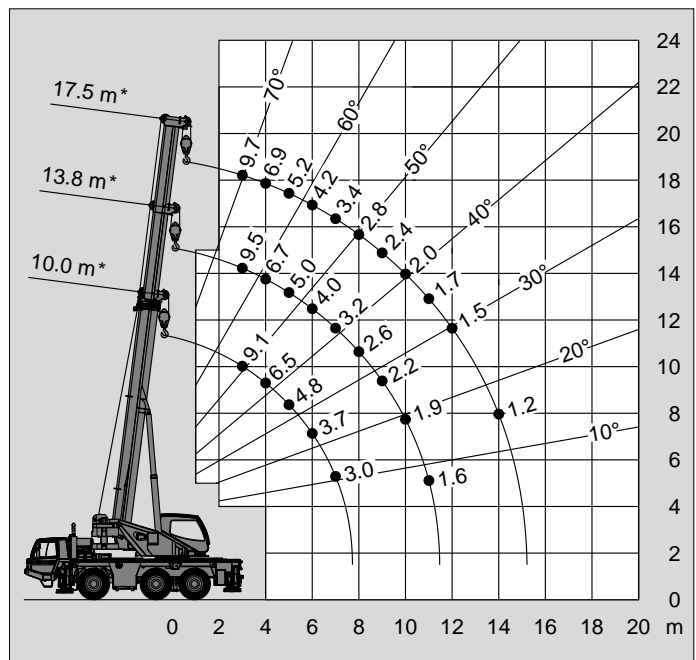



Tragfähigkeiten  
Lifting capacities  
Capacités de levage  
Capacidades de elevación

Hubhöhen  
Lifting heights  
Hauteurs de levage  
Alturas de elevación



→ m	10.0 m*	13.8 m*	17.5 m*
3.0	6.5	6.9	7.1
3.5	5.5	5.9	6.1
4.0	4.7	5.0	5.2
4.5	4.1	4.4	4.6
5.0	3.5	3.8	4.0
6.0	2.7	3.0	3.1
7.0	2.1	2.4	2.6
8.0		1.9	2.1
9.0		1.6	1.8
10.0		1.3	1.5
11.0		1.1	1.3
12.0			1.1
14.0			0.7
16.0			

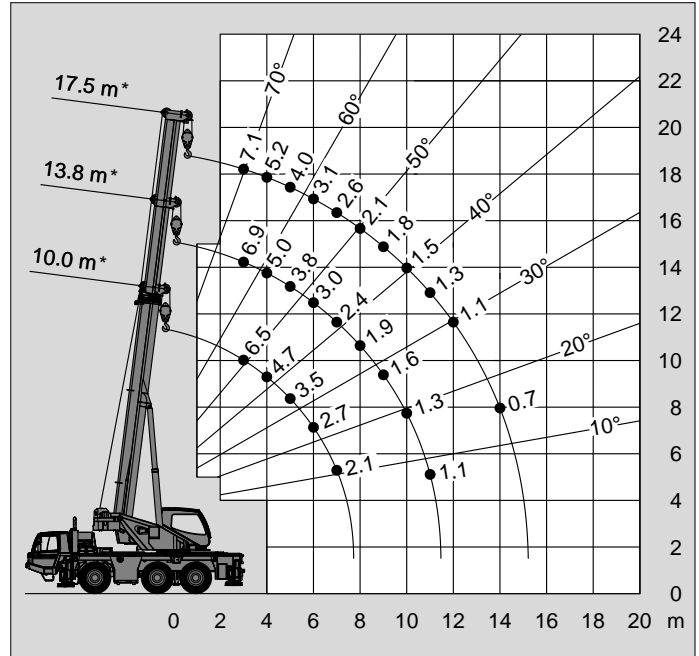

\* Oberwagenverriegelung eingelegt \* Superstructure verrouillé  
\* Superstructure locked \* Bloqueo de superestructura

**Anmerkungen zu den Traglasttabellen**

Die Tragfähigkeiten im Festigkeitsbereich basieren auf DIN 15018 Blatt 2 und Blatt 3 und F.E.M.

Die Tragfähigkeiten im Standsicherheitsbereich entsprechen DIN 15019 Teil 2 / ISO 4305 / EN 13000.

In Abhängigkeit der Auslegerlänge sind bei den Traglasttabellen Windgeschwindigkeiten von 10 m/s bis max. 15 m/s zulässig.

Die Tragfähigkeiten sind in metrischen Tonnen angegeben.

Das Gewicht des Lasthakens bzw. der Hakenflasche und weiterer Anschlagmittel ist von der Tragfähigkeit abzuziehen.

Die Tragfähigkeiten für den Teleskopausleger gelten nur bei demon- tierter Spitze.

Die Ausladung ist der horizontale Abstand von Mitte Drehkranz bis Mitte freihängender, nicht schwingender Last.

Tragfähigkeitsänderungen vorbehalten.

Obige Angaben dienen nur zur Information. Die Bedienungsanlei- tungen müssen zu Rate gezogen werden, bevor die Maschine in Betrieb genommen wird. Alle hier gemachten Angaben beziehen sich auf die Standard-Ausführung. Jegliche Ausrüstungsverände- rungen können die angegebenen Werte beeinflussen.

**Remarks relating to the rating charts**

The lifting capacities in the structural area are based on DIN 15018 parts 2 and 3 and F.E.M.

The lifting capacities in the stability area are based on DIN 15019 part 2 / ISO 4305 / EN 13000.

Maximum admissible wind velocity for working with telescopic boom is 15 m/sec to 10 m/sec depending at boom length and for working with fly jib 10 m/sec.

The lifting capacities are shown in metric tons.

The weight of load handling devices such as hook blocks, slings, etc., must be considered as part of the load and must be deducted from the lifting capacities.

The lifting capacities for the telescopic boom apply to a crane with no boom extensions being stowed or mounted on the crane.

The working radius is the horizontal distance from the centre of rotation to the centre of the freely suspended non-oscillating load.

The lifting capacities are subject to change without prior notice.

The above remarks are for basic information only and the operator's manual must be consulted before operating this crane. All data and performances refer to the standard crane. The addition of optional and other equipment may affect the performance of the crane.

**Remarques relatives aux tableaux des charges**

Les forces de levage sont conformes aux normes DIN 15018, p. 2 et 3, et F.E.M.

Les forces de levage dans la partie de stabilité au renversement sont conformes aux normes DIN 15019, chap. 2 / ISO 4305 / EN 13000.

Des vitesses de vent sont admissibles entre 10 m/s jusqu'à max 15 m/s en fonction de la longueur de flèche.

Les forces de levage sont données en tonnes métriques.

Le poids du crochet-moufle et de tous les accessoires d'élingage font partie de la charge et sont à déduire des charges indiquées.

Les forces de levage indiquées pour la flèche télescopique s'entendent fléchette déposée.

Comme portée, on entend la distance horizontale du centre de la couronne de rotation au centre de la charge librement suspendue et non oscillante.

Sauf modification de forces de levage.

Les données ci-dessus servent à titre d'information. Avant la mise en marche de la grue il est conseillé d'étudier les instructions de service. Toutes les données indiquées ci-dessus se réfèrent à la machine de base. Tout changement de l'équipement de la grue peut influencer ces valeurs.

**Notas relativas a los graficos de carga**

En cuanto a los datos referentes a resistencia, las capacidades de carga están basados sobre las normas DIN 15018, pág. 2 y 3, y F.E.M.

En cuanto a los datos referentes a estabilidad anti-vuelco, las capacidades de carga están basados sobre las normas DIN 15019, Cap. 2 / ISO 4305 / EN 13000.

En independencia a la longitud de la pluma, están toleradas velocidades de viento de entre 10 m/s y 15 m/s.

Las capacidades de carga indicadas en las tablas corresponden a toneladas métricas.

Hay que deducir los pesos del gancho, eslingas y de otros dispositivos para fijación de cargas de los valores indicados en las tablas.

Las capacidades de carga referentes a la pluma telescópica valen solamente si el plumín está desmontada.

Como alcance se entiende la distancia horizontal desde el centro de la corona de giro hasta el centro de la carga suspendida libremente y no oscilante.

Salvo modificación de capacidades de carga, sin previo aviso.

Los datos arriba indicados sirven solamente para su información. Hay que leer las instrucciones para el uso antes de la puesta en servicio de la máquina. Todos los datos mencionados en las presentes tablas rigen para los modelos standard. Cualquier modificación del equipo montado puede dar lugar a modi-ficaciones de aquellos valores.

Gegengewichtvarianten  
Counterweight versions  
Variations des contrepoids  
Variaciones de contrapeso

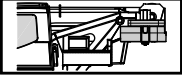
	<b>Gegengewicht / Counterweight Contrepoids / Contrapeso</b>	2x	1x	1x	1x	1x
	(t)	①	②	③	④	⑤
		0.4	4.1	1.0	2.0	2.1

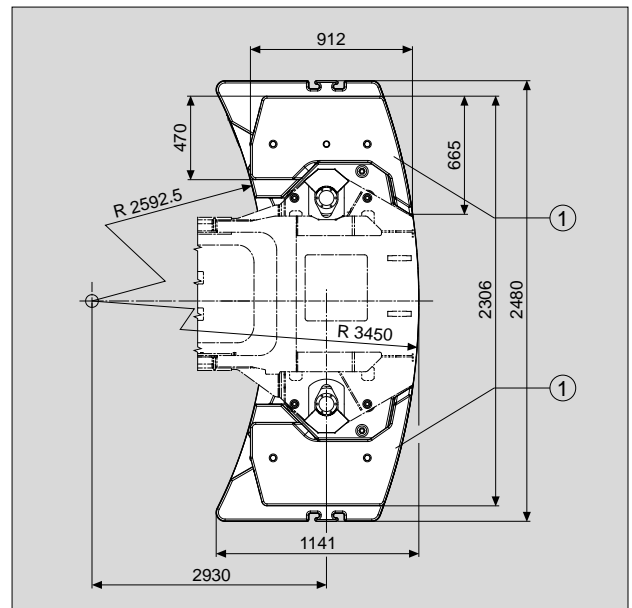
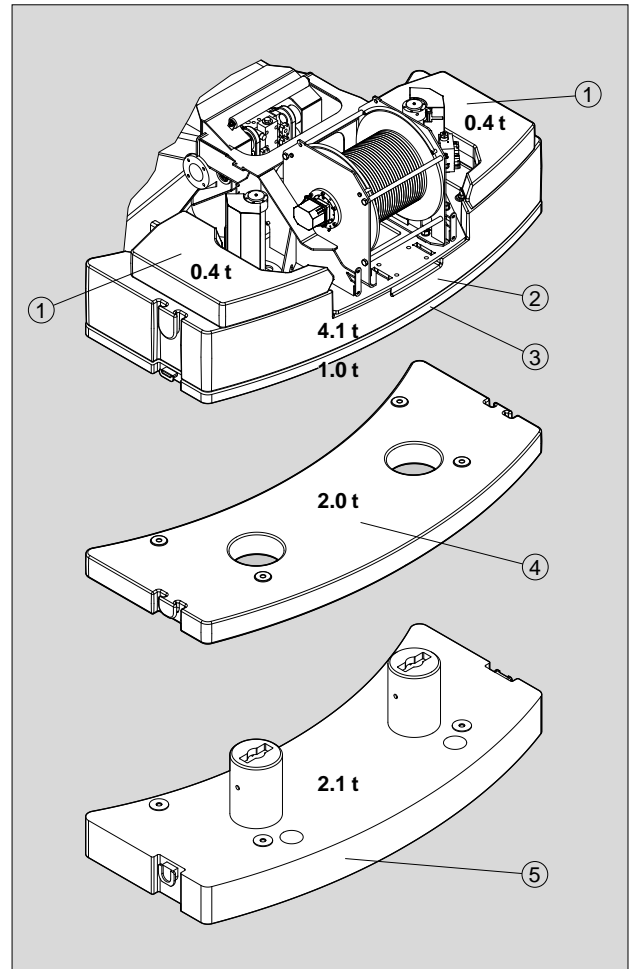
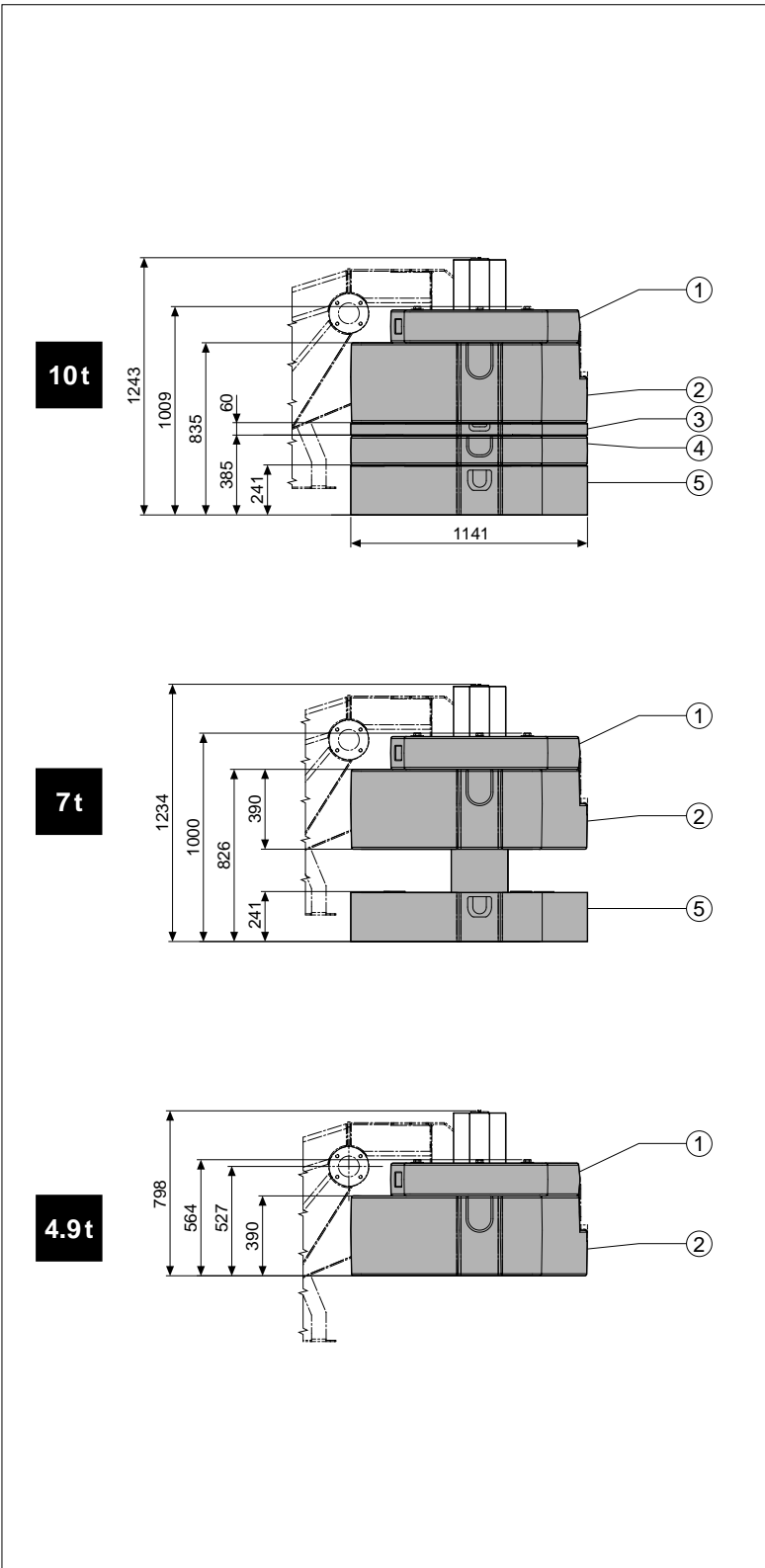

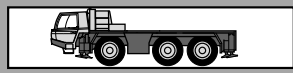

**Rahmen** Verwindungs- und biegesteife Schweißkonstruktion aus hochfestem Feinkornstahl.

**Abstützung** 4-Punkt-Abstützung, hydraulisch, Bedienungsmöglichkeiten an beiden Seiten des Fahrgestelles und in der Oberwagenkabine.  
Abstützbasis 6,3 m (und 4,3 m) x 7,2 m.

**Motor** Mercedes-Benz 6-Zylinder-Dieselmotor OM 926 LA (Euromot III B), wassergekühlt, Leistung 240 kW (326 PS) bei 2200 min<sup>-1</sup>. Drehmoment 1300 Nm (132,5 kpm) bei 1300 bis 1600 min<sup>-1</sup>. Motorleistung nach 80/1269/EWG. Kraftstoffbehälter 350 l. AdBlue-Behälter 40 l.

**Getriebe** ZF-AS-Tronic 12 AS 2302 mechanisches Schaltgetriebe mit elektronisch-pneumatisch betätigter Trockenkupplung und vollautomatischer Schaltung mit 12 Vorwärts- und 2 Rückwärtsgängen.  
Power/Economy Modus.

**Antrieb** 6 x 6

#### Achsen

1. Achse: gelenkt, angetrieben, Differentialsperre quer.
2. Achse: gelenkt, angetrieben, Differentialsperre längs und quer.
3. Achse: gelenkt, angetrieben, Differentialsperre quer.

**Achsaufhängung** Hydropneumatische Federung mit Niveauregulierung.

**Bremsen** Druckluft-Zweikreis-Bremsanlage mit ABS-System. Feststellbremse als Federspeicherbremse an der 2. und 3. Achse wirkend. Konstantdrosselanlage mit Auspuffklappenbremse als Dauerbremse.

**Räder** 6-fach 385/95 R 25 (14.00 R 25), Breite 2,55 m.

**Lenkung** ZF-Servocom-Zweikreislenkung. Mechanische Lenkung der 1. Achse und Mitlenken der 3. Achse (bis zu einer Geschwindigkeit von 25 km/h), hydraulisch unterstützt, mit Notlenkpumpe. Lenkung aller Achsen möglich. Hydrostatische Lenkung aller Achsen aus der Oberwagenkabine.

**Unterwagenkabine** Zwei-Mann-Frontfahrerhaus in Stahl-Kunststoff-Verbund-Konstruktion, Sicherheitsverglasung, luftgefederte Sitze (Fahrersitz mit Heizung) und motorabhängige Warmwasserheizung, Radio-CD-Player, Kontroll- und Bedienungselemente für den Fahrbetrieb. Tempomat-Funktion.

**Elektrische Anlage** 24 Volt-Gleichstrom, 2 Batterien, Die elektrische Anlage entspricht der EG-Norm.

**Zusatzrüstung** (gegen Mehrpreis)  
Anhängerkupplung, Wirbelstrombremse, motorunabhängige Zusatzheizung mit Motorvorwärmung, Klimaanlage, 445/95 R 25 (16.00 R 25) Bereifung, Reserverad, Zentralschmieranlage, Sonderlackierung und Beschriftung.

Weitere Zusatzrüstung auf Anfrage.

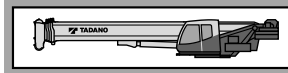

**Rahmen** Verwindungssteife Schweißkonstruktion mit einer außenverzahnten, einreihigen Kugeldrehverbindung, um 360° unbegrenzt drehbar.

**Hydraulik System** Diesel-hydraulisch mit 3-Kreis-Hydraulik, 1 Axialkolbendoppelpumpe (hydraulisch verstellbar) und 1 Zahnradpumpe, Ölkühler, alle Pumpen vom Unterwagenmotor angetrieben. Bei Kranbetrieb: 204 kW (277 PS) bei 1500 min<sup>-1</sup> (DIN 6270B).

**Steuerung** Zwei 4-fach Kreuzsteuerhebel mit hydraulischer Vorsteuerung.

**Teleskopausleger** Fünfteiliger Teleskopausleger aus hochfestem Feinkornstahl, bestehend aus einem Grundaussleger und 4 Teleskopteilen, zwei einstufigen Teleskopzylindern und Seilen, hydraulisch unter Teillast teleskopierbar. 10,0 m - 40,0 m lang.

**Wippwerk** Ein Differentialzylinder mit angebautem Senkbremssperrventil.

**Hubwerk** Axialkolben-Motor, Hubwerkstrommel mit eingebautem Planetengetriebe und federbelasteter Hydro-Lamellenbremse mit integriertem Freilauf beim Heben. Hubseil mit 'Super-Stop' Einrichtung.

**Drehwerk** Axialkolben-Motor, zweistufiges Planetengetriebe mit fußbetätigter Betriebsbremse und Feststellung. Drehgeschwindigkeit stufenlos von 0 - 1,9 min<sup>-1</sup>.

**Gegengewicht** Standard 7 t teilbar. Die Bedienung erfolgt aus der Oberwagenkabine.

**Oberwagenkabine** Großräumige Krankabine in Stahl-Kunststoff-Ausführung mit Sicherheitsverglasung und getönten Scheiben, kippbarem Arbeitsplatz mit verstellbarem, hydraulisch gedämpftem Fahrersitz, motorunabhängige Warmwasserheizung, Radio-CD-Player, Kontroll- und Bedienungselemente für Kranbetrieb, Verfahrbarkeit vom Oberwagen und Abstützbetätigung.

**Elektrische Anlage** 24 Volt-Gleichstrom, 2 Batterien.

**Sicherheitseinrichtungen** Lastmomentbegrenzung (LMB), Arbeitsbereichsanzeige, Hubendschalter, Windenendschalter, Seilwindendrehmelder, Sicherheitsventile gegen Rohr- und Schlauchbrüche. Sperrventile an Hydraulik-Zylindern.

**Zusatzrüstung** (gegen Mehrpreis)  
Auslegerverlängerung 9,0 m / 16,0 m, Schwerlastspitze 1,6 m, Zusatzgegengewicht 3 t, Gegengewichtsvarianten 4,9 t, 10 t, verschiedene Unterflaschen, Klimaanlage, Arbeits- und Drehbereichsbegrenzung, Zusatzölkühler, Zentralschmieranlage, Sonderlackierung und Beschriftung.

Weitere Zusatzrüstung auf Anfrage.

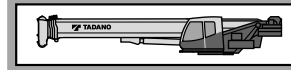
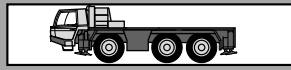

**Frame** Torsion resistant, welded construction made from high strength, fine-grained steel.

**Outriggers** 4 point, telescopic hydraulic outriggers with controls on both sides of carrier and in superstructure cab. Outrigger base 6.3 m (4.3 m mid extension) x 7.2 m.

**Carrier engine** Mercedes-Benz 6 cylinder model OM 926 LA (Euromot III B), water-cooled diesel engine. Rated at 240 kW (326 HP) at 2200 min<sup>-1</sup>. Torque 1300 Nm (132.5 kpm) at 1300 - 1600 min<sup>-1</sup>. Engine rating according to 80/1269/EWG. Fuel tank 350 l. AdBlue-tank 40 l.

**Transmission** ZF-AS-Tronic 12 AS 2302 mechanical transmission with electro-pneumatically operated dry-type clutch and automatic gear shifting with 12 forward gears and 2 reverse gears. Power/Economy mode.

**Drive** 6 x 6

#### Axles

1<sup>st</sup> axle: steered, driven.  
2<sup>nd</sup> axle: steered, driven, with longitudinal differential lock.  
3<sup>rd</sup> axle: steered, driven.  
All driven axles with transverse differential locks.

**Suspension** Hydro-pneumatic with levelling adjustment.

**Brake system** Service brakes: dual circuit compressed air system with ABS. Parking brake: spring loaded type acting on 2<sup>nd</sup> and 3<sup>rd</sup> axles. Auxiliary brakes: engine exhaust brake and constant throttle engine brake system.

**Tyres** (6) 385/95 R 25 (14.00 R 25), width 2.55 m.

**Steering system** ZF Servocom dual circuit hydraulic steering, mechanical hydraulically-assisted steering of 1<sup>st</sup> axle and 3<sup>rd</sup> axle up to a travel speed of 25 km/h, emergency steering pump. Steering of all axles possible. All axles steered hydrostatically from superstructure cab.

**Carrier cab** Two man full width cab of composite (steel sheet metal and fibre-glass) structure, with safety glass, air-cushioned adjustable seats (driver seat with heater) and engine dependent hot-water heater, radio-CD-player, complete controls and instrumentation for road travel. Speed control.

**Electrical system** 24 volt DC system, 2 batteries. Electrical system conforms with EEC regulations.

#### Optional Equipment (at extra charge)

Towing attachment, eddy current retarder brake, engine independent additional heater with engine pre-heat, air conditioning, 445/95 R 25 (16.00 R 25) tyres, spare wheel and tyre, central lubricating system, special painting and lettering.

Further optional equipment available upon request.

**Frame** Torsion-resistant, all-welded structure of high strength steel. Connected to carrier by single-row ball-bearing slewing ring with external gearing for 360° continuous rotation.

**Hydraulic system** Three circuit diesel hydraulic system with 1 double axial piston pump (hydraulically adjustable) and 1 gear pump, oil cooler. Pumps driven by carrier engine rated at 204 kW (277 HP) at 1500 min<sup>-1</sup> (DIN 6270B).

**Controls** Hydraulic, 2 joy-stick levers for simultaneous operation of crane motions.

**Telescopic boom** 5 sections, made of high tensile, fine-grained steel, consisting of 1 base section and 4 telescoping sections extended by means with two single telescopic cylinders and ropes. All telescope sections extendable under partial load. 10.0 m to 40.0 m long.

**Derricking system** 1 double acting hydraulic cylinder with integral brake and holding valve.

**Main winch** Axial piston motor, winch drum with integrated planetary reduction and with hydraulically controlled spring-loaded, multiple disc brake and with integrated free rotation (no sagging of load when hoisting). Hoist cable with 'Super-Stop' easy reeving system.

**Slewing system** Axial piston motor with two-stage planetary reduction with a foot actuated service and a parking brake. Speed infinitely variable 0 - 1.9 min<sup>-1</sup>.

**Counterweight** Standard 7 t divisible, assembled and disassembled by hydraulic cylinders controlled from superstructure cab.

**Superstructure cab** Spacious panoramic cab of composite structure with safety (tinted) glass windows, tiltable cockpit with hydraulically cushioned adjustable seat, engine independent hot-water heater, radio-CD-player, complete controls and instrumentation for crane operation, on-site travelling and outriggers.

**Electrical system** 24 volt DC system, 2 batteries.

**Safety devices** Load moment device (LMD), working area display, hoist limit switch, lower limit switch, drum turn indicator, safety valves against pipe and hose rupture. Holding valves on hydraulic cylinders.

#### Optional Equipment (at extra charge)

Boom extensions 9.0 m to 16.0 m, heavy duty jib 1.6 m additional counterweight 3.0 t, counterweight variations 4.9 t, 10.0 t, selection of hook blocks, air conditioning, working area limitation, additional oil cooler, central lubricating system, special painting and lettering.

Further optional equipment available upon request.

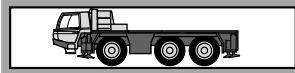

**Châssis** Construction mécanosoudé, en acier à grain fin très rigide, résistant aux flexions et aux torsions.

**Calage** Dispositif de calage horizontal et vertical en 4 points, entièrement déployable hydrauliquement. Commande des mouvements sur les deux côtés du porteur et depuis la cabine de la superstructure. Calage 6,3 m (aussi 4,3 m) x 7,2 m.

**Moteur** Mercedes-Benz diesel 6 cylindres, modèle OM 926 LA (Euromot III B), refroidi par eau, de 240 kW (326 CV) à 2200 min<sup>-1</sup>.  
Couple: 1300 Nm (132,5 kpm) à 1300 à 1600 min<sup>-1</sup>.  
Puissance selon 80 / 1269 / EWG.  
Capacité du réservoir 350 l.  
AdBlue-capacité du réservoir 40 l.

**Boîte de vitesse** Boîte mécanique ZF-AS-Tronic, modèle 12 AS 2302 avec embrayage électro-pneumatique réglé à commande et boîte automatique, 12 vitesses AV et 2 vitesses AR. Mode max. performance / économique.

**Entraînement** 6 x 6

#### Essieux

- 1<sup>er</sup> essieu: directeur, entraîné, blocage de différentiel transversal.
- 2<sup>ème</sup> essieu: directeur, entraîné, blocage de différentiel longitudinal et transversal.
- 3<sup>ème</sup> essieu: directeur, entraîné, blocage de différentiel transversal.

**Suspension** Hydro-pneumatique, avec réglage de niveau.

**Freins** Système à air comprimé, à double circuit, avec système ABS. Frein de stationnement: avec accumulateurs à ressort agissant sur le 2<sup>ème</sup> et 3<sup>ème</sup> essieu. Frein continu: Frein sur échappement avec étrangleur.

**Pneus** 6 x 385/95 R 25 (14.00 R 25), (largeur 2,55 m).

**Direction** Servocom à double circuit, marque ZF. Direction mécanique du 1<sup>er</sup> essieu, à assistance hydraulique, jusqu'à une vitesse de 25 km/h direction automatique du 3<sup>ème</sup> essieu, avec pompe de direction auxiliaire. Direction de tous les essieux possible. Direction hydro-statique de tous les essieux depuis la cabine du grutier.

**Cabine** Cabine bi-place, construction en matière composite fibre de verre et acier. Vitrage en verre de sécurité, siège conducteur chauffant suspendu hydrauliquement. Chauffage à eau chaude relié au moteur, radio-CD-player. Organes de contrôle et de commande pour la conduite. Régulateur de vitesse.

**Système électrique** 24 V courant continu, 2 batteries. Conforme aux normes CE.

**Équipement supplémentaire** (avec supplément de prix) Attache-remorque, frein électrique, chauffage auxiliaire indépendant du moteur avec préchauffage du moteur, climatisation, pneus 445/95 R 25 (16.00 R 25), roue de secours, graissage centralisé, peinture spéciale et inscription. Autres équipements supplémentaires sur demande.

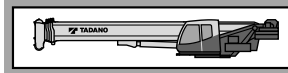

**Plate forme** Construction mécano-soudée résistante à la torsion. Couronne d'orientation à billes à une rangée, à denture extérieure, permettant une rotation illimitée sur 360°.

**Système hydraulique** Diesel-hydraulique à 3 circuits, 1 double pompe à pistons axiaux (à réglage hydraulique) et 1 pompe à engrenages, refroidisseur d'huile, pompes actionnées du moteur châssis.  
Opération grue: 204 kW (277 CV) à 1500 min<sup>-1</sup> selon DIN 6270B.

**Commande** 2 manipulateurs à commande en croix (4 sens), assistés hydrauliquement.

**Flèche télescopique** 1 flèche de base et 4 éléments télescopiques en acier fin avec 2 vérins hydrauliques à 1 étage et câbles, hydrauliquement télescopable avec charge partielle. Logueur 10,0 m à 40,0 m.

**Mécanisme de relevage** 1 vérin différentiel muni de clapet de freinage de descente.

**Mécanisme de levage** Moteur hydraulique, tambour de levage avec boîte planétaire incorporée, frein d'arrêt à disques multiples à ressort, libéré lors du levage. Câble de levage avec dispositif 'Super-Stop'.

**Orientation** Moteur hydraulique avec entraînement planétaire à 2 gammes. Frein de service actionné par l'intermédiaire d'une pédale et frein de stationnement. Vitesse de rotation 0 à 1,9 min<sup>-1</sup> en continu.

**Contrepoids** Standard 7 t divisible, commandé de la cabine du grutier.

**Cabine du grutier** Cabine de grue spacieuse, construction en matière combinée acier / synthétique, avec vitrage de sécurité en verre teinté, siège chauffant, réglable et amorti hydrauliquement, inclinable avec instruments de commande, chauffage à eau chaude indépendant du moteur, radio-CD-player, éléments de commande et de contrôle pour travaux sur chantier, conduite et calage de la grue depuis la cabine du grutier.

**Système électrique** 24 V courant continu, 2 batteries.

**Dispositifs de sécurité** Limiteur de charge (CEC), indicateur de portée, interrupteur de fin de course de levage et de treuil, indicateur du nombre de tours, soupapes de sécurité contre ruptures des conduites et flexibles, clapets sur vérins hydrauliques.

**Équipement supplémentaire** (avec supplément de prix) Fléchette 9,0 m / 16,0 m, fléchette pour levage lourde 1,6 m, contrepoids additionnel de 3 t, combinaison différentes de contrepoids 4,9 t / 10 t, sélection de moufles, 2<sup>ème</sup>, refroidisseur d'huile supplémentaire, graissage centralisé, peinture spéciale et inscription.

Autres équipements supplémentaires sur demande.

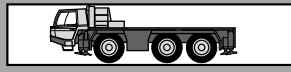

**Chasis portante** Construcción de acero de alta resistencia soldado, resistente a la torsión y a la flexión.

**Estabilizadores** Estabilizadores hidráulicos de 4 puntos. Posibilidad de manejo desde ambos lados del chasis portante y desde la cabina de la grúa. Extensión de los estabilizadores: 6,3 m (y 4,3 m) x 7,2 m.

**Motor** Mercedes-Benz modelo OM 926 LA (Euromot III B), 6 cilindros, diesel, refrigerado por agua. Nominal 240 kW (326 CV) a 2200 min<sup>-1</sup>. Par 1300 Nm (132,5 kpm) a 1300 hasta 1600 min<sup>-1</sup>. Potencia del motor según 80 / 1269 / EWG. Depósito de combustible de 350 l. Depósito AdBlue 40 l.

**Transmisión** Transmisión mecánica tipo ZF-AS Tronic modelo 12 AS 2302 con accionamiento electro - neumáticamente embrague en seco y cambio automático 12 marchas delanteras y 2 marchas traseras. Modo rendimiento máximo / económico.

**Tracción** 6 x 6

#### Ejes

- 1º eje: de dirección, accionado, con bloqueo diferencial transversal.
- 2º eje: de dirección, accionado, con bloqueo diferencial transversal y longitudinal.
- 3º eje: de dirección, accionado, con bloqueo diferencial transversal.

**Suspensión** Suspensión hidroneumática con regulación de nivel.

**Sistemas de frenos** Accionamiento neumático de doble circuito con sistema anti bloqueo ABS. Freno de estacionamiento del tipo muelles cargados, liberados por aire, sobre los ejes 2º y 3º. Freno continuo: Freno de motor diesel en el escape.

**Neumáticos** 6 x 385/95 R 25 (14.00 R 25), ancho 2,55 m.

**Dirección** Hidráulica ZF Servocom de doble circuito. Dirección mecánica del 1º eje y direccionable del 3º eje (hasta una velocidad de 25 km/h), con bomba hidráulica de emergencia accionada por la transmisión. Dirección de todos los ejes posible. Desde la cabina de la superestructura: dirección hidro-estática de ambos ejes.

**Cabina** Cabina para dos personas, en construcción de acero y fibra de vidrio. Cristales de seguridad, asiento con suspensión neumática, asiento de conductor calefactado. Calefacción por agua caliente del motor, radio-CD-player. Elementos de control y manejo para circular por carretera. Regulador de velocidad.

**Sistema eléctrico** Sistema de 24 V c.c. con 2 baterías. El sistema eléctrico cumple la normativa CEE.

**Equipo adicional** (con suplemento de precio) Embrague de remolque, freno eléctrico, calefacción adicional con precalefacción del motor, climatización, neumáticos 445/95 R 25 (16.00 R 25), rueda de repuesto, sistema de engrase central, pintura especial e rotulación. Otros equipamientos sobre pedido.

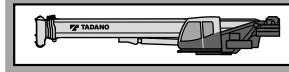

**Superestructura** Construida en aceros soldados, resistente a la torsión. Corona de giro con rodamiento de una fila de bolas con dientes externos para giro continuo de 360°.

**Sistema hidráulico** Sistema hidráulico de 3 circuitos, 1 bomba doble de pistones axiales (regulable hidráulicamente) y una bomba de ruedas dentadas, enfriador de aceite. Las bombas están accionadas desde el motor del chasis. Operación de la grúa: 204 kW (277 CV) a 1500 min<sup>-1</sup>. (DIN 6270B).

**Mandos** 2 palancas de control de tipo joy-stick para movimientos simultáneos de la grúa (4 direcciones), asistidos hidráulicamente.

**Pluma telescópica** 5 secciones, un tramo base y 4 telescópicos de acero de alta resistencia soldado con 2 cilindros telescópicos sencillos y cables, los tramos se pueden telescopar hidráulicamente bajo carga. Longitud de 10,0 m a 40,0 m.

**Elevación de pluma** Mediante un cilindro hidráulico de doble efecto con válvula de retención integrada.

**Cabrestante principal** Motor hidráulico de pistones axiales y caudal fijo. Tambor del cabrestante con reducción planetaria y frenos de disco múltiples accionado, con sistema libre de elevación. Cable de elevación con sistema fácil de guiado 'Super-Stop'.

**Sistema de giro** Motor hidráulico de pistones axiales con reducción planetaria de dos etapas. Freno de servicio controlado por pedal y freno de estacionamiento. Velocidad de giro variable de 0 - 1,9 min<sup>-1</sup>.









**Contrapeso** El estándar 7 t divisible, accionado desde la cabina de la grúa.

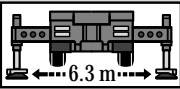

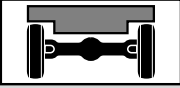



**Cabina de la grúa** Cabina espaciosa y confortable, en construcción de acero y fibra de vidrio, con cristales tintados de seguridad. Asiento de operador regulable amortiguado hidráulicamente, inclinable junto con los instrumentos y mandos, asiento calefactado. Calefacción por agua caliente independiente del motor, radio-CD-player. Elementos de control y mando para el manejo de la grúa y para el desplazamiento en obra. Mandos para nivelación y extensión de los estabilizadores.

**Sistema eléctrico** Sistema de 24 V c.c. con 2 baterías.

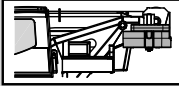
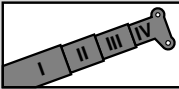
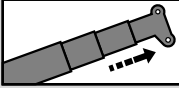
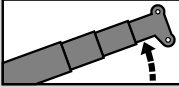
**Medidas de seguridad** Limitación del momento de carga (LMC), limitación del área de trabajo, interruptor de final de elevación, interruptor de 3 últimas vueltas en cabrestante, indicador de bajada o subida del cable del cabrestante, válvulas de seguridad para rotura de tubos y latiguillos. Válvulas de retención en los cilindros hidráulicos.

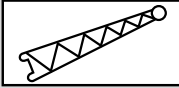
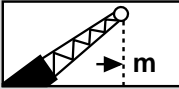
**Equipo adicional** (con suplemento de precio) Plumín de 9,0 m / 16,0 m, plumín de carga pesada de 1,6 m, contrapeso adicional de 3 t, variantes de contrapeso 4,9 t / 10 t, selección de ganchos, climatización, limitación del área de trabajo y limitador de giro, enfriador adicional, sistema de engrase central, pintura especial e rotulación. Otros equipamientos sobre pedido.

	Siehe Seite 18 As on Page 18 Voyez la page 18 Véase la pagina 18
	Abstützung Outriggers Calage Estabilizadores
	Getriebe / Gang Transmission / Gear Boîte de vitesse / Rapport Transmisión / Marchas
	Achslast Axle load Charge à l'essieu Carga por eje
 <b>385/95 (14.00)</b>	Räder / Größe Tyres / Size Pneus / Largeur Neumáticos / Tamaño de ruedas
	Geschwindigkeiten Speeds Vitesses Velocidades
	Steigfähigkeit Gradeability Abtitude en pente Superacion de pendientes
	Drehwerk Slewing system Orientation Sistema de giro
	Gegengewicht Counterweight Contrepoids Contrapeso
	Nach hinten Over rear A l'arrière Sobre la parte trasera

	Gegengewichtvarianten Counterweight versions Variations des contrepoids Variaciones de contrapeso
	Teleskopausleger Telescopic boom Flèche télescopique Pluma telescópica
	Teleskopieren Boom telescoping Télescopage de flèche Telescopaje de pluma
	Wippwerk Derricking system Mécanisme de relevage Elevación de pluma
	Ausladung Radius Portée Radio
	Auslegerverlängerung Boom extension Fléchette Plumín
	Ausladung Radius Portée Radio
	Hubwerk Main winch Mécanisme de levage Cabrestante principal
	2. Hubwerk Auxiliary winch 2 <sup>ème</sup> treuil de levage 2 <sup>º</sup> cabrestante
	Unterflasche / Hakengeschirr Hook block / Swivel hook Moufle / Elingues Gancho / Gancho de bola



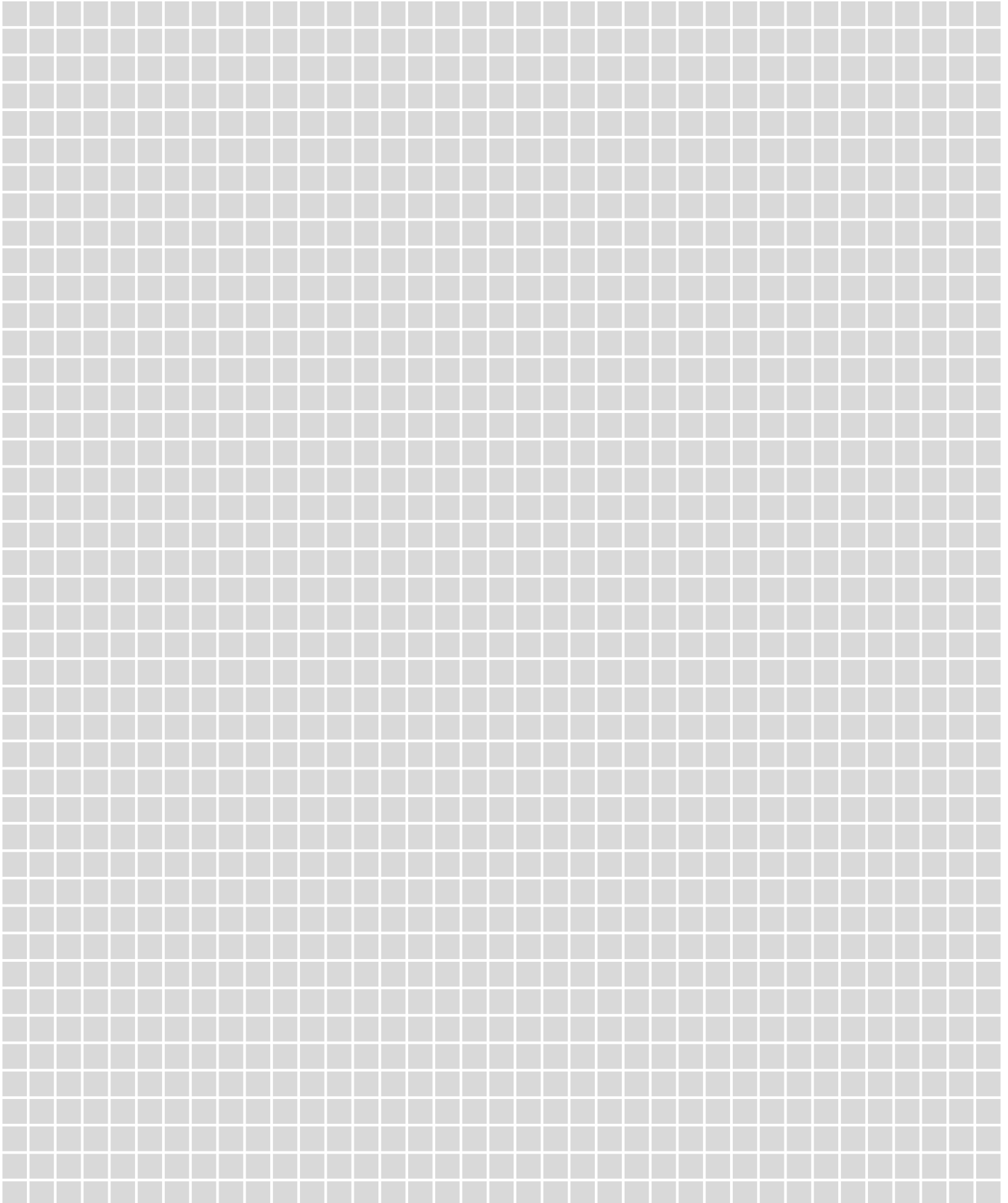

## Worldwide offices

---

### International

#### TADANO Ltd.

International Division  
4-12, Kamezawa 2-chome  
Sumida-Ku, Tokyo 130-0014, Japan  
Phone: +81-3-3621-7750  
Fax: +81-3-3621-7785  
E-mail: [tdnihq@tadano.co.jp](mailto:tdnihq@tadano.co.jp)

#### TADANO America Corporation

4242 West Greens Road  
Houston, TX 77066, USA  
Phone: +1-281-869-0030  
Fax: +1-281-869-0040  
E-mail: [sales@tadano-cranes.com](mailto:sales@tadano-cranes.com)

#### TADANO MANTIS Corporation

1705 Columbia Avenue, Suite 200  
Franklin, Tennessee USA 37065  
Phone: +1-800-272-3325  
Fax: +1-615-790-6803  
E-mail: [sales@mantisranes.com](mailto:sales@mantisranes.com)

#### TADANO Ltd. Middle East Representative Office

P.O.Box 18302, LOB15-323  
Jebel Ali Free Zone, Dubai, UAE  
Phone: +971-4-887-1353  
Fax: +971-4-887-1703  
E-mail: [tadano@tadano.ae](mailto:tadano@tadano.ae)

#### TADANO Oceania Pty Ltd.

4/12 Archimedes Street Darra  
Queensland 4076  
Australia  
Phone: +61-7-3120-8750  
Fax: +61-7-3120-8760  
E-mail: [pshelton@tadano.com.au](mailto:pshelton@tadano.com.au)

#### TADANO Ltd. Beijing Office

Jing Guang Centre, Room 2905  
Hu Jia Lou, Chao Yang Qu  
Beijing, China  
Phone: +86-10-6597-3210  
Fax: +86-10-6597-3220  
E-mail: [beijing@tadano.co.jp](mailto:beijing@tadano.co.jp)

#### TADANO South China Co. Ltd.

Room 1803, 18/F Seaview Commercial  
Building 21-24 Connaught Road West  
Hong Kong  
Phone: +852-2544-9310  
Fax: +852-2541-5828  
E-mail: [info@tadanosc.com](mailto:info@tadanosc.com)

#### TADANO Korea Co. Ltd.

Dangok Bldg 2F, #642-7, Bokjeong-dong  
Sujeong-gu, Seongnam-si, Gyeonggi-do  
461-830, Korea  
Phone: +82-2-714-1600  
Fax: +82-2-3274-1304  
E-mail: [tadano@korea.com](mailto:tadano@korea.com)

#### TADANO Asia Pte Ltd.

11 Tuas View Crescent  
Multico Building  
Singapore 637643  
Phone: +65-6863-6901  
Fax: +65-6863-6902  
E-mail: [Tdn-crane@tadanoasia.com](mailto:Tdn-crane@tadanoasia.com)

#### Taiwan TADANO Ltd.

16F, No. 39, Sec. 2 Twng-Hwa S. Rd.  
Taipei  
Taiwan  
Phone: +886-2-2754-0252  
Fax: +886-2-2709-2086  
E-mail: [tadano@ms18.hinet.net](mailto:tadano@ms18.hinet.net)

### Europe

#### TADANO FAUN GmbH

Faunberg 2  
91207 Lauf a. d. Pegnitz  
Germany  
Phone: +49-9123-955-0  
Fax: +49-9123-3085  
E-mail: [info@tadanofaun.de](mailto:info@tadanofaun.de)

---

Detaillierte Informationen über unsere Internationalen Händler und Service Niederlassungen finden Sie im Internet.  
For detailed information about our International Distributor and Service Network, please refer to our homepages.  
[www.tadano.co.jp](http://www.tadano.co.jp) + [www.tadanoamerica.com](http://www.tadanoamerica.com) + [www.mantisranes.com](http://www.mantisranes.com) + [www.tadanofaun.de](http://www.tadanofaun.de)

### Herausgeber / Publisher:

#### TADANO FAUN GmbH

P.O.Box 10 02 64  
91205 Lauf  
Germany

