



GR-800EX

Left hand steering

GENERAL DATA

CRANE CAPACITY		80,000 kg at 3.0 m
BOOM		5-section, 12.0 m - 47.0 m
DIMENSION		
Overall length	approx.	14,375 mm
Overall width	approx.	3,315 mm
Overall height	approx.	3,795 mm
MASS		
Gross vehicle mass	approx.	51,410 kg
— front axle	approx.	24,325 kg
— rear axle	approx.	27,085 kg
PERFORMANCE		
Max. travelling speed	computed	36 km/h
Gradeability(tan θ)	computed	94 % (at stall) *30 %

*Machine should be operated within the limit of engine crankcase design (17° : MITSUBISHI 6M60-TL)

CRANE SPECIFICATIONS

MODEL
GR-800EX

CAPACITY
80,000 kg at 3.0 m

BOOM
5-section full power partially synchronized telescoping boom of round box construction with 6 sheaves at boom head. The synchronization system consists of 2 telescope cylinders, extension cables and retraction cables. Hydraulic cylinders fitted with holding valves.
Fully retracted length12.0 m
Fully extended length 47.0 m
Extension speed35.0 m in 160 s

JIB
2-staged swingaround boom extension. Triple offset (3.5°/25°/45°) type. Stows alongside base boom section. Assistant cylinders for mounting and stowing. Single sheave at jib head.
Length.....10.1 m and 17.7 m

SINGLE TOP (AUXILIARY BOOM SHEAVE)
Single sheave. Mounted to main boom head for single line work.

ELEVATION
By a double-acting hydraulic cylinder, fitted with a holding valve. Automatic speed reduction and slow stop function.
Boom angle..... -1.5° to 80.5°
Boom raising speed..... 20° to 60° in 46s

HOIST—Main winch
Variable speed type with grooved drum driven by hydraulic axial piston motor through winch speed reducer. Power load lowering and hoisting. Equipped with automatic brake (neutral brake) and counterbalance valve. Controlled independently of auxiliary winch.
Single line pull64.7 kN {6,600 kgf}
Single line speed (High)....149 m/min (at the 4th layer)
Single line speed (Low)107 m/min (at the 4th layer)
Wire rope.....No-spin type
Diameter x length19 mm x 250 m

HOOK BLOCK(Optional) - 80 t capacity
7 sheaves, swivel type hook with safety latch.

HOOK BLOCK(Optional) - 50 t capacity
5 sheaves, swivel type hook with safety latch.

HOOK BLOCK(Optional) - 35 t capacity
3 sheaves, swivel type hook with safety latch.

HOIST—Auxiliary winch

Variable speed type with grooved drum driven by hydraulic axial piston motor through winch speed reducer. Power load lowering and hoisting.

Equipped with automatic brake (neutral brake) and counter-balance valve.

Controlled independently of main winch.

- Single line pull64.7 kN {6,600 kgf}
- Single line speed(High).....149 m/min (at the 4th layer)
- Single line speed(Low).....107 m/min (at the 4th layer)
- Wire rope.....No-spin type
- Diameter x length19 mm x 139 m

HOOK BLOCK - 6.6 t capacity

Swivel hook with safety latch for single line use.

SWING

Hydraulic axial piston motor driven through planetary speed reducer. Continuous 360° full circle swing on ball bearing slew ring. Equipped with manually locked/released swing brake.

- Swing speed1.5 min⁻¹ {rpm}

HYDRAULIC SYSTEM

- Pumps.....2 variable piston pumps for telescoping, elevating and winches.
Tandem gear pump for steering, swing and optional equipment.
- Control valvesMultiple valves actuated by pilot pressure with integral pressure relief valves.
- Circuit.....Equipped with air cooled type oil cooler.
Oil pressure appears on AML display for main circuit.
- Hydraulic oil tank capacity.....
approx. 840 liters
- FiltersReturn line filter

CRANE CONTROL

By 4 control levers for swing, boom hoist, main winch, boom telescoping or auxiliary winch with 2 control pedals for boom hoist and boom telescoping based on ISO standard layout. Control lever stands can change neutral positions and tilt for easy access to cab.

CAB

Both crane and drive operations can be performed from one cab mounted on rotating superstructure. One sided one-man type, steel construction with sliding door access and tinted safety glass windows opening at side. Door window is powered control.

Operator's 3 way adjustable seat with headrest and armrest. Hot water cab heater and air conditioning.

TADANO Automatic Moment Limiter (AML) (Model:AML-C)

Main unit in crane cab gives audible and visual warning of approach to overload. Automatically cuts out crane motions before overload.

With working range (load radius and/or boom angle and/or tip height and/or swing range) limit function.

Automatic Speed Reduction and Soft Stop function on boom elevation and swing.

Following functions are displayed.

- Load as percentage
- Number of parts of line of rope
- Boom angle
- Boom length
- Load radius
- Outriggers position
- On-tire indicator
- Actual hook load
- Permissible load
- Boom position indicator
- Potential hook height
- Swing angle
- Main hydraulic oil pressure
- Jib length and jib offset angle (only when jib operation)

OUTRIGGERS

Hydraulically operated H-type outriggers. Each outrigger controlled simultaneously or independently from the cab. Equipped with sight level gauge. Floats mounted integrally with the jacks retract to within vehicle width.

All cylinders fitted with pilot check valves.

Crane operation with different extended length of each outrigger. Equipped with extension width detector for each outrigger.

- Extended width
- Fully 7,300 mm
- Middle 6,700 mm
- Middle 5,500 mm
- Minimum 2,700 mm
- Float size (diameter) 600 mm

COUNTERWEIGHT

Integral with swing frame (containing weight with auxiliary winch and wirerope)

- Mass..... 9,980 kg

NOTE : Each crane motion speed is based on unladen conditions.

TYPE

Rear engine, left-hand steering, driving axle 2-way selected type (by manual switch).

- 4 x 2 front drive
- 4 x 4 front and rear drive

FRAME

High-tensile steel, all welded mono-box construction.

ENGINE

Model.....MITSUBISHI 6M60-TL

Type.....4 cycle, turbo charged and after cooled, 6 cylinder in line, direct injection, water cooled diesel engine.

Piston displacement7,545 cm³

Bore x stroke118 mm x 115 mm

Max. output.....200 kW at 2,600 min⁻¹{rpm}

Max. torque785 N-m at 1,400 min⁻¹{rpm}

TRANSMISSION

Electronically controlled full automatic transmission.

Torque converter driving full powershift with driving axle selector.

6 forward and 2 reverse speeds.

3 speeds - High range - 2 wheel drive ; 4 wheel drive

3 speeds - Low range - 4 wheel drive

AXLES

Front.....Full floating type, steering and driving axle with planetary reduction.

Rear.....Full floating type, steering and driving axle with planetary reduction.

Non-spin differential.

STEERING

Hydraulic power steering controlled by steering wheel.

Four steering modes available:

- 2-wheel front
- 2-wheel rear
- 4-wheel coordinated
- 4-wheel crab

SUSPENSION

FrontRigid mounted to the frame.

Rear.....Pivot mounted with hydraulic lockout cylinders.

BRAKE SYSTEM

ServiceAir over hydraulic disc brakes on all 4 wheels.

Parking / Emergency.....

Spring applied-air released brake acting on input shaft of front axle.

Auxiliary....Electro-pneumatic operated exhaust brake.

ELECTRIC SYSTEM

24 V DC. 2 batteries of 12 V - 120 Ah capacity.

FUEL TANK CAPACITY

300 liters

TIRES

Front29.5–25 34PR(OR), Single x 2 Air pressure:400 kPa

Rear29.5–25 34PR(OR), Single x 2 Air pressure:400 kPa

TURN RADIUS

Min. turning radius (at center of extreme outer tire)

2-wheel steering 11.9 m

4-wheel steering 6.8 m

EQUIPMENT**STANDARD EQUIPMENT**

Automatic Moment Limiter (AML)

External lamp (AML)

Pendant type over-winding cutout

Winch automatic fail-safe brake

Cable follower

6.6 t capacity hook block (swivel hook)

Hook safety latch

Pilot check valves

Holding valves

Counterbalance valves

Hydraulic pressure relief valves

Swing brake

Swing lock

Boom angle indicator

Boom elevation foot pedal

Boom telescoping foot pedal

Outrigger extension width detector

Air conditioner (hot water heater and cooler)

Sight level gauge

Hydraulic oil cooler

Electric windshield wiper and washer

Roof window wiper and washer

Power window (cab door)

Tachometer/Speedometer

3 way adjustable cloth seat with seat belt, headrest and armrest

Cab floor mat

Sun visor (front and roof)

Automatic drive system

Transmission neutral position engine start

Overshift prevention

Parking braked travel warning

Tilt-telescope steering wheel

Emergency steering

Back-up alarm

Air cleaner dust indicator

Air dryer

Water separator with filter

Engine over-run alarm

Hydraulic lockout suspension

Non-spin differential (rear)

Towing eyes - front and rear

Telematics(machine data logging and monitoring system) with HELLO-NET via internet (availability depends on countries).

Eco mode system

Winch drum rotation indicator (audible and visual type)

Winch drum mirror

Fuel consumption monitor

Positive control

2-speed hoist

Eco mode system

OPTIONAL EQUIPMENT

80 t capacity hook block (7 sheaves)

50 t capacity hook block (5 sheaves)

35 t capacity hook block (3 sheaves)

Over-unwinding prevention

Tire inflation kit

Telescoping mode I

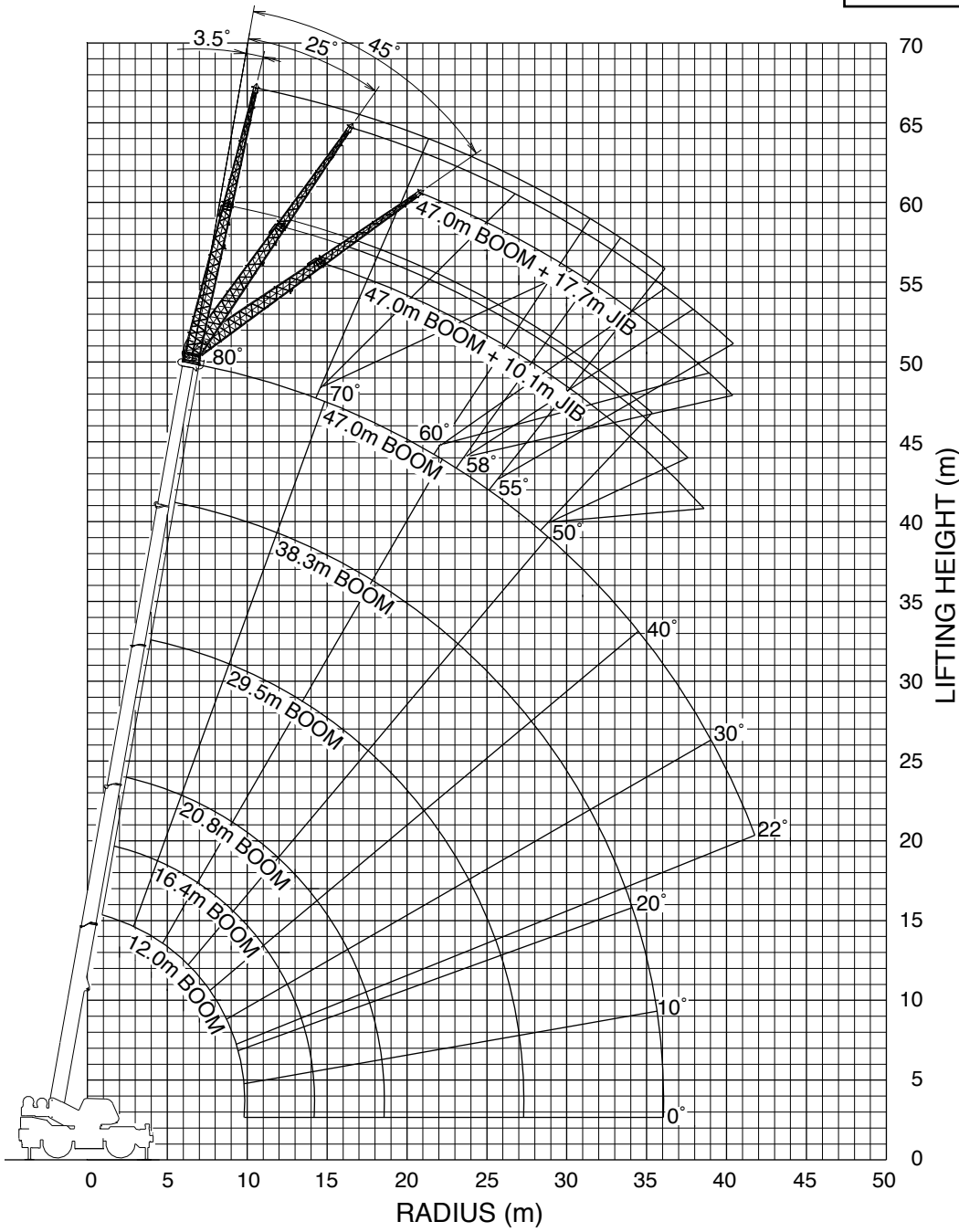

BOOM

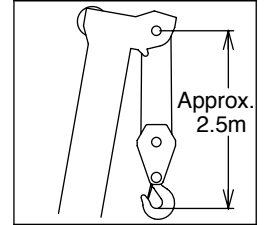

JIB

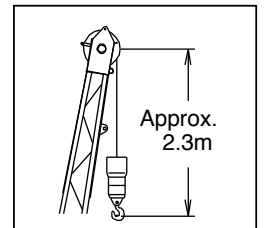

SINGLE TOP

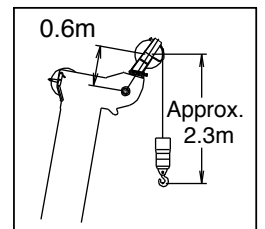

Boom Length

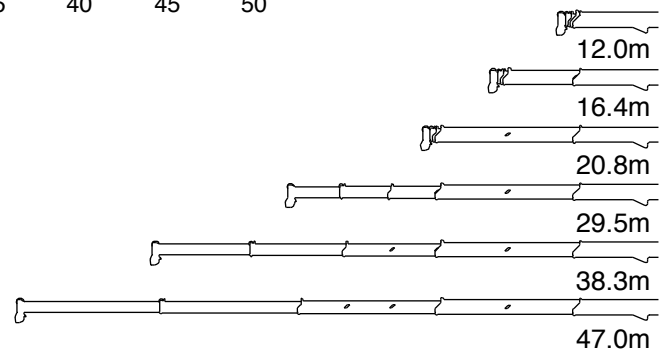

NOTE: The above lifting height and boom angle are based on a straight (unladen) boom, and allowance should be made for boom deflection obtained under laden conditions. The above working range is shown on condition with outriggers fully (7.3m) extended.

Telescoping mode II

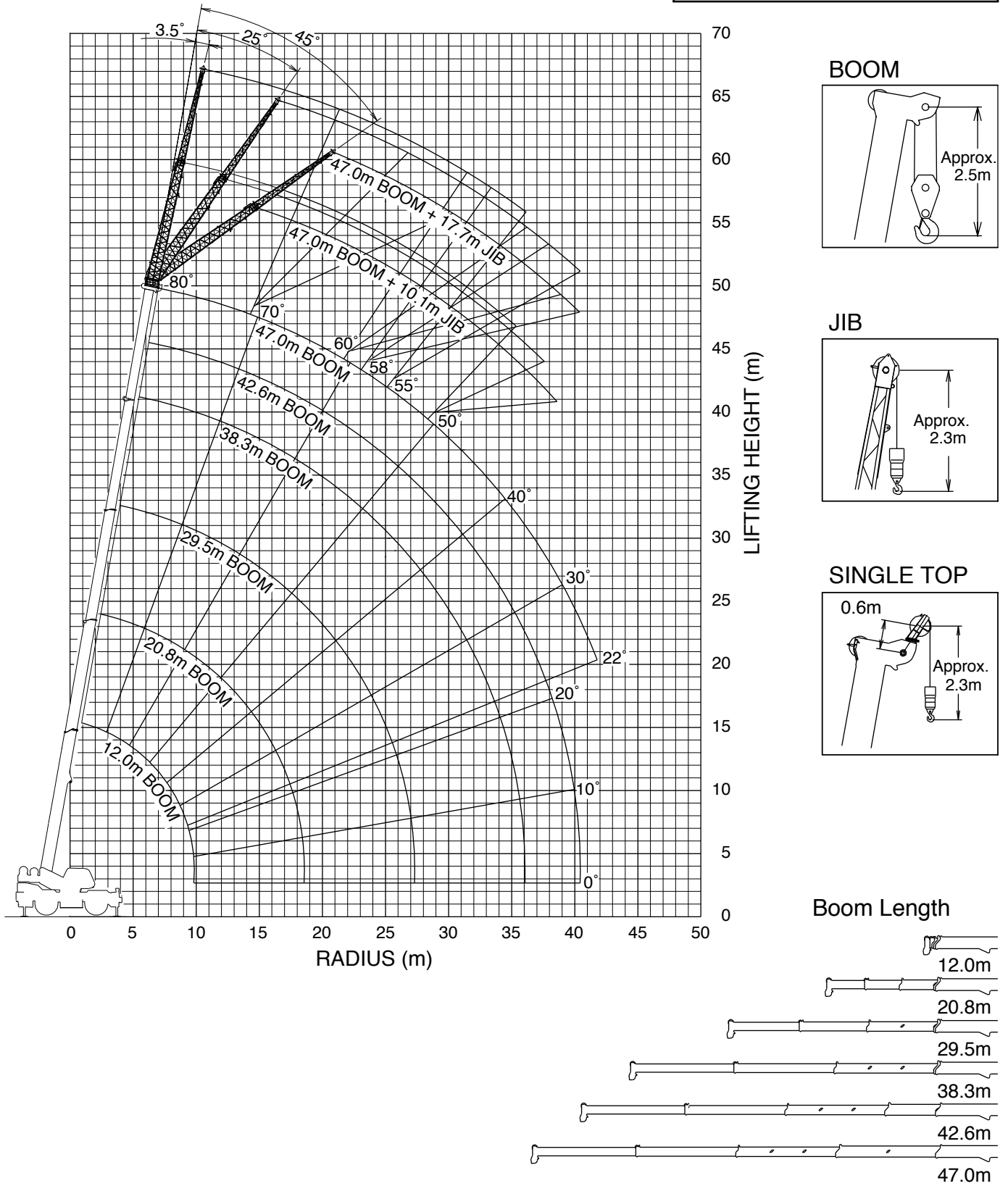

NOTE: The above lifting height and boom angle are based on a straight (unladen) boom, and allowance should be made for boom deflection obtained under laden conditions. The above working range is shown on condition with outriggers fully (7.3m) extended.

ON OUTRIGGERS

ON OUTRIGGERS FULLY EXTENDED 7.3m SPREAD 360° ROTATION (Unit: x1000kg)																
B	A		12.0m		16.4m		20.8m		29.5m		38.3m		42.6m		47.0m	
	C		C		C		C		C		C		C		C	
3.0	70	80.0	75	46.6	79	40.9	78	18.2								
3.5	67	74.2	74	46.6	77	40.9	77	18.2								
4.0	64	67.0	72	46.6	76	40.9	76	18.2								
4.5	62	60.9	70	46.6	75	40.9	74	18.2								
5.0	59	55.7	68	46.6	73	38.9	73	18.2	79	18.2	78	15.1				
5.5	56	51.1	66	46.6	72	36.8	71	18.2	78	18.2	77	15.1				
6.0	53	46.2	64	45.8	70	34.9	70	18.2	77	18.2	76	15.1				
6.5	49	42.1	62	41.7	69	33.2	68	18.2	76	18.2	75	15.1				
7.0	46	38.6	60	38.3	67	31.6	67	18.2	75	18.2	75	15.1	79	15.1	79	13.0
7.5	42	35.6	58	34.4	66	30.1	65	18.2	74	18.2	74	15.1	78	15.1	78	13.0
8.0	38	33.0	56	31.0	64	28.1	64	18.2	73	18.2	73	15.1	78	15.1	78	12.8
9.0	27	24.0	51	24.9	61	23.3	60	18.2	71	18.2	71	15.1	76	15.1	76	12.1
10.0			46	20.2	58	19.7	57	18.2	69	18.2	69	15.0	75	14.6	75	11.3
11.0			40	16.7	54	16.3	54	18.2	67	16.6	66	14.0	74	13.8	73	10.7
12.0			34	14.0	50	13.6	50	16.4	65	14.6	64	13.2	72	13.0	72	10.1
14.0			13	10.2	42	9.9	42	12.4	60	11.2	60	11.7	69	11.3	68	9.0
16.0					32	7.3	32	9.8	55	8.6	55	10.3	65	9.1	65	8.1
18.0					16	5.5	16	7.5	50	6.7	50	8.3	62	7.2	62	7.4
20.0									44	5.3	44	6.9	58	5.8	58	6.8
22.0									38	4.2	38	5.7	54	4.7	54	5.9
24.0									30	3.3	30	4.8	50	3.8	50	5.0
26.0									20	2.5	20	4.0	46	3.0	46	4.2
28.0													41	2.4	41	3.6
30.0													36	1.9	36	3.1
32.0													29	1.5	30	2.6
34.0													22	1.1	22	2.2
36.0															30	1.4
38.0															23	1.1
40.0															12	0.9
D																

Telescoping conditions(%)

Telescoping Mode	I, II	I	I	II	I	II	I	II	II	I, II
2nd boom	0	50	100	0	100	0	100	0	50	100
3rd boom	0	0	0	33	33	66	66	100	100	100
4th boom	0	0	0	33	33	66	66	100	100	100
Top boom	0	0	0	33	33	66	66	100	100	100

LIFTING CAPACITIES AT ZERO DEGREE BOOM ANGLE ON OUTRIGGERS FULLY EXTENDED 7.3m SPREAD 360° ROTATION (Unit: x1000kg)																		
C	A		12.0m		16.4m		20.8m		29.5m		38.3m		42.6m					
	B		B		B		B		B		B		B					
0°	9.8	20.3	14.1	10.0	18.4	5.2	18.4	7.2	27.2	2.2	27.0	3.7	35.8	0.8	35.0	2.1	40.0	0.9
Telescoping Mode	I, II		I		I		II		I		II		I		II		II	

- A: Boom length (m)
- B: Load radius (m)
- C: Loaded boom angle (°)
- D: Minimum boom angle (°) for indicated boom length (no load)

ON OUTRIGGERS

ON OUTRIGGERS FULLY EXTENDED 7.3m SPREAD 360° ROTATION (Unit: x1000kg)						
C	47.0m Boom + 10.1m Jib					
	3.5°Tilt		25°Tilt		45°Tilt	
	R	W	R	W	R	W
80	10.9	4.9	14.2	4.9	16.7	4.3
79	11.8	4.9	15.2	4.7	17.7	4.2
78	12.9	4.9	16.4	4.6	18.6	4.1
77	14.0	4.9	17.4	4.5	19.5	4.0
76	15.1	4.9	18.4	4.4	20.5	3.9
75	16.0	4.9	19.3	4.2	21.7	3.9
73	18.2	4.8	21.3	4.0	23.5	3.7
70	21.2	4.4	24.2	3.8	26.3	3.5
68	23.2	4.1	26.0	3.6	28.0	3.4
65	26.0	3.8	28.6	3.4	30.5	3.1
63	27.8	3.2	30.2	2.9	31.9	2.7
60	30.0	2.5	32.4	2.3	33.9	2.2
58	31.7	2.1	34.0	2.0	35.2	1.9
55	33.9	1.6	35.9	1.5	37.0	1.5
53	35.3	1.4	37.2	1.3	38.4	1.2
50	37.4	1.0	39.3	1.0	40.2	0.9

C	47.0m Boom + 17.7m Jib					
	3.5°Tilt		25°Tilt		45°Tilt	
	R	W	R	W	R	W
80	12.8	3.1	19.1	2.9	23.8	2.3
79	14.1	3.1	20.5	2.8	24.7	2.3
78	15.5	3.1	21.7	2.7	26.0	2.3
77	16.9	3.1	22.7	2.7	27.0	2.3
76	18.1	3.1	24.1	2.6	28.0	2.2
75	19.4	3.1	25.2	2.6	29.0	2.2
73	21.9	3.1	27.3	2.5	30.0	2.2
70	25.6	3.1	30.4	2.4	33.8	2.1
68	27.8	3.0	32.4	2.3	35.7	2.1
65	30.8	2.7	35.3	2.2	38.1	2.0
63	32.7	2.3	36.9	2.0	39.6	1.8
60	35.2	1.7	39.3	1.5	41.9	1.4
58	36.7	1.4	40.8	1.3	43.0	1.2
55	39.2	1.0	43.3	0.9		

ON OUTRIGGERS FULLY EXTENDED 7.3m SPREAD 360° ROTATION (Unit: x1000kg)						
C	42.6m Boom(telescoping mode II) + 10.1m Jib					
	3.5°Tilt		25°Tilt		45°Tilt	
	R	W	R	W	R	W
80	9.4	5.3	13.4	5.2	15.6	4.6
79	10.4	5.3	14.3	5.1	16.5	4.5
78	11.3	5.3	15.3	5.0	17.5	4.4
77	12.4	5.3	16.3	4.8	18.3	4.3
76	13.5	5.3	17.2	4.7	19.2	4.2
75	14.5	5.3	18.1	4.6	19.9	4.1
73	16.5	5.2	19.8	4.3	21.6	4.0
70	19.2	4.7	22.5	4.0	23.9	3.7
68	21.1	4.5	24.1	3.9	25.5	3.6
65	23.5	4.1	26.4	3.6	27.6	3.4
63	25.2	3.9	28.0	3.5	29.1	3.3
60	27.5	3.5	30.2	3.2	31.1	3.0
58	28.9	3.1	31.6	2.9	32.4	2.7
55	31.1	2.6	33.6	2.4	34.3	2.3
53	32.5	2.3	34.8	2.1	35.3	2.0
50	34.4	1.9	36.5	1.8	37.0	1.7
48	35.7	1.7	37.7	1.6	38.1	1.5
45	37.5	1.4	39.3	1.3	39.5	1.3
43	38.6	1.2	40.4	1.1		
40	40.3	1.0	41.9	0.9		

C	42.6m Boom(telescoping mode II) + 17.7m Jib					
	3.5°Tilt		25°Tilt		45°Tilt	
	R	W	R	W	R	W
80	11.5	3.3	18.5	3.0	22.6	2.4
79	12.6	3.3	19.6	2.9	23.4	2.3
78	13.8	3.3	20.4	2.8	24.5	2.3
77	15.1	3.3	21.3	2.8	25.5	2.3
76	16.3	3.3	22.3	2.7	26.4	2.3
75	17.5	3.3	23.3	2.7	27.3	2.3
73	19.6	3.3	25.4	2.6	28.9	2.2
70	23.0	3.3	28.3	2.5	31.5	2.1
68	25.2	3.3	30.1	2.4	33.1	2.1
65	28.1	3.0	32.8	2.3	35.4	2.1
63	30.2	2.9	34.6	2.3	36.9	2.0
60	32.7	2.6	36.9	2.2	39.2	2.0
58	34.3	2.2	38.4	2.0	40.4	1.9
55	36.7	1.8	40.6	1.7	42.2	1.6
53	38.0	1.6	41.7	1.4	43.4	1.4
50	40.2	1.3	43.7	1.2	45.0	1.1
48	41.6	1.1	45.0	1.0	46.0	1.0

ON OUTRIGGERS FULLY EXTENDED 7.3m SPREAD 360° ROTATION (Unit: x1000kg)						
C	38.3m Boom(telescoping mode I) + 10.1m Jib					
	3.5°Tilt		25°Tilt		45°Tilt	
	R	W	R	W	R	W
80	8.4	6.6	12.5	6.4	14.7	4.9
79	9.3	6.6	13.4	6.2	15.5	4.8
78	10.3	6.6	14.1	6.0	16.3	4.7
77	11.2	6.6	15.1	5.9	17.1	4.7
76	12.1	6.6	15.8	5.7	18.0	4.6
75	13.0	6.6	16.6	5.6	18.6	4.6
73	14.9	6.6	18.2	5.4	20.1	4.5
70	17.4	6.2	20.6	5.1	22.3	4.4
68	19.0	5.9	22.1	4.9	23.6	4.4
65	21.4	5.5	24.3	4.7	25.7	4.3
63	22.8	4.8	25.6	4.3	26.9	3.9
60	24.9	3.9	27.3	3.5	28.7	3.3
58	26.2	3.4	28.6	3.1	29.8	2.9
55	28.0	2.8	30.3	2.6	31.5	2.5
53	29.5	2.5	31.5	2.3	32.6	2.2
50	31.3	2.1	33.1	1.9	34.2	1.8
48	32.5	1.8	34.2	1.7	35.1	1.6
45	34.2	1.5	35.7	1.4	36.5	1.3
43	35.3	1.3	36.7	1.2		
40	36.8	1.0	38.2	1.0		
38	37.7	0.9				

C	38.3m Boom(telescoping mode I) + 17.7m Jib					
	3.5°Tilt		25°Tilt		45°Tilt	
	R	W	R	W	R	W
80	10.5	4.0	17.1	3.2	20.8	2.4
79	11.6	4.0	18.0	3.1	21.7	2.3
78	12.7	4.0	19.0	3.0	22.6	2.3
77	13.7	4.0	19.9	3.0	23.5	2.3
76	14.8	4.0	20.7	2.9	24.4	2.3
75	15.9	4.0	21.7	2.9	25.2	2.3
73	18.0	4.0	23.5	2.8	26.8	2.2
70	20.8	3.8	26.1	2.6	29.1	2.1
68	22.7	3.6	27.8	2.6	30.7	2.1
65	25.4	3.4	30.4	2.5	32.8	2.1
63	27.3	3.2	31.9	2.4	34.2	2.1
60	29.8	2.8	34.2	2.3	36.2	2.0
58	31.2	2.4	35.5	2.1	37.5	2.0
55	33.5	2.0	37.5	1.8	39.2	1.7
53	34.9	1.7	38.6	1.5	40.4	1.5
50	37.0	1.4	40.4	1.2	41.8	1.2
48	38.3	1.2	41.6	1.1	42.7	1.0
45	40.2	0.9				

C: Loaded boom angle (°)

R: Load radius(m)

W: Rated lifting capacity(Unit:x1,000kg)

ON OUTRIGGERS

ON OUTRIGGERS MID EXTENDED 6.7m SPREAD																	
360° ROTATION (Unit: x1000kg)																	
B \ A	12.0m		16.4m		20.8m			29.5m			38.3m		42.6m		47.0m		
	C		C		C		C		C		C		C		C		
3.0	70	80.0	76	46.6	79	40.9	78	18.2									
3.5	67	72.1	74	46.6	77	40.9	77	18.2									
4.0	65	65.0	72	46.6	76	40.9	76	18.2									
4.5	62	59.0	70	46.6	75	40.9	74	18.2									
5.0	59	53.8	68	46.6	73	38.9	73	18.2	79	18.2	78	15.1					
5.5	55	49.3	66	46.6	72	36.8	71	18.2	78	18.2	77	15.1					
6.0	52	44.0	64	43.5	70	34.5	70	18.2	77	18.2	76	15.1					
6.5	49	40.0	62	38.0	69	32.0	68	18.2	76	18.2	75	15.1					
7.0	46	35.5	60	33.6	67	30.0	67	18.2	75	18.2	74	15.1	79	15.1	79	13.0	
7.5	42	31.8	58	30.1	66	27.3	65	18.2	74	18.2	74	15.1	78	15.1	78	13.0	
8.0	37	27.8	55	27.1	64	24.6	64	18.2	73	18.2	73	15.1	78	15.1	78	12.8	
9.0	27	22.0	51	21.3	61	20.4	61	18.2	71	18.2	71	15.1	76	15.1	76	12.1	
10.0			46	17.2	57	16.8	57	18.2	69	17.0	69	15.0	75	14.6	75	11.3	
11.0			40	14.2	54	13.8	54	16.7	67	14.7	66	14.0	73	13.8	73	10.7	
12.0			34	11.9	50	11.5	50	14.2	64	12.9	64	13.2	72	12.6	72	10.1	
14.0			13	8.6	42	8.2	42	10.8	60	9.6	60	11.3	69	10.0	68	9.0	
16.0					32	6.0	32	8.4	55	7.3	55	8.9	65	7.9	65	8.1	
18.0					16	4.3	15	6.7	50	5.6	50	7.2	62	6.2	62	7.2	
20.0									44	4.3	44	5.9	58	4.9	58	6.1	
22.0									38	3.3	38	4.8	54	3.9	54	5.1	
24.0									30	2.5	31	4.0	50	3.1	50	4.2	
26.0									20	1.9	20	3.4	46	2.4	46	3.5	
28.0													41	1.8	41	3.0	
30.0													36	1.4	36	2.5	
32.0													30	1.0	29	2.1	
34.0															21	1.7	
36.0															30	1.0	
D							0°						6°		0°	23°	34°

Telescoping conditions(%)

Telescoping Mode	I, II	I	I	II	I	II	I	II	II	II	I, II
2nd boom	0	50	100	0	100	0	100	0	50	100	100
3rd boom	0	0	0	33	33	66	66	100	100	100	100
4th boom	0	0	0	33	33	66	66	100	100	100	100
Top boom	0	0	0	33	33	66	66	100	100	100	100

LIFTING CAPACITIES AT ZERO DEGREE BOOM ANGLE ON OUTRIGGERS MID EXTENDED																
6.7m SPREAD 360° ROTATION (Unit: x1000kg)																
C \ A	12.0m		16.4m		20.8m			29.5m			38.3m					
	B		B		B		B		B		B		B		B	
0°	9.8	18.0	14.2	8.3	18.5	4.0	18.3	6.5	27.2	1.5	27.2	3.0			35.4	1.6
Telescoping Mode	I, II		I		I		II		I		II				II	

- A: Boom length (m)
- B: Load radius (m)
- C: Loaded boom angle (°)
- D: Minimum boom angle (°) for indicated boom length (no load)

ON OUTRIGGERS

ON OUTRIGGERS MID EXTENDED 6.7m SPREAD 360° ROTATION (Unit: x1000kg)						
C	47.0m Boom + 10.1m Jib					
	3.5°Tilt		25°Tilt		45°Tilt	
	R	W	R	W	R	W
80	10.8	4.9	14.3	4.9	16.7	4.3
79	11.9	4.9	15.4	4.7	17.8	4.2
78	13.0	4.9	16.4	4.6	18.8	4.1
77	14.1	4.9	17.6	4.5	19.8	4.0
76	15.2	4.9	18.5	4.4	20.8	3.9
75	16.1	4.9	19.6	4.2	21.9	3.9
73	18.3	4.8	21.5	4.0	23.6	3.7
70	21.2	4.4	24.3	3.8	26.4	3.5
68	23.1	3.9	26.0	3.5	28.0	3.2
65	25.7	3.0	28.2	2.7	30.2	2.5
63	27.4	2.5	29.9	2.3	31.6	2.2
60	29.9	1.9	32.3	1.8	33.8	1.7
58	31.4	1.6	33.8	1.5	35.1	1.4
55	33.7	1.2	35.7	1.1	37.0	1.0
53	35.1	0.9				

ON OUTRIGGERS MID EXTENDED 6.7m SPREAD 360° ROTATION (Unit: x1000kg)						
C	47.0m Boom + 17.7m Jib					
	3.5°Tilt		25°Tilt		45°Tilt	
	R	W	R	W	R	W
80	12.8	3.1	19.1	2.9	23.8	2.3
79	14.1	3.1	20.5	2.8	24.7	2.3
78	15.5	3.1	21.6	2.7	26.1	2.3
77	16.9	3.1	22.9	2.7	27.2	2.3
76	18.1	3.1	24.2	2.6	28.1	2.2
75	19.4	3.1	25.4	2.6	29.2	2.2
73	21.9	3.1	27.5	2.5	31.1	2.2
70	25.6	3.1	30.5	2.4	33.9	2.1
68	27.6	2.7	32.5	2.3	35.7	2.1
65	30.2	2.0	35.0	1.8	37.9	1.7
63	32.3	1.7	36.4	1.5	39.3	1.4
60	34.6	1.2	38.9	1.1	41.4	1.0
58	36.4	1.0				

ON OUTRIGGERS MID EXTENDED 6.7m SPREAD 360° ROTATION (Unit: x1000kg)						
C	42.6m Boom(telescoping mode II) + 10.1m Jib					
	3.5°Tilt		25°Tilt		45°Tilt	
	R	W	R	W	R	W
80	9.3	5.3	13.3	5.2	15.7	4.6
79	10.4	5.3	14.3	5.1	16.5	4.5
78	11.5	5.3	15.2	5.0	17.4	4.4
77	12.5	5.3	16.2	4.8	18.4	4.3
76	13.6	5.3	17.2	4.7	19.1	4.2
75	14.5	5.3	18.1	4.6	19.9	4.1
73	16.4	5.2	19.7	4.3	21.6	4.0
70	19.2	4.7	22.3	4.0	23.9	3.7
68	21.1	4.5	24.0	3.9	25.5	3.6
65	23.5	4.1	26.4	3.6	27.6	3.4
63	25.1	3.7	27.9	3.3	28.9	3.1
60	27.2	3.0	29.9	2.7	30.9	2.6
58	28.7	2.6	31.3	2.4	32.2	2.3
55	30.7	2.1	33.2	1.9	34.0	1.9
53	32.1	1.8	34.5	1.7	35.1	1.6
50	34.1	1.5	36.3	1.4	36.8	1.3
48	35.4	1.3	37.4	1.2	37.9	1.2
45	37.2	1.0	39.2	1.0	39.4	0.9

ON OUTRIGGERS MID EXTENDED 6.7m SPREAD 360° ROTATION (Unit: x1000kg)						
C	42.6m Boom(telescoping mode II) + 17.7m Jib					
	3.5°Tilt		25°Tilt		45°Tilt	
	R	W	R	W	R	W
80	11.5	3.3	18.6	3.0	22.5	2.4
79	12.7	3.3	19.4	2.9	23.4	2.3
78	13.8	3.3	20.4	2.8	24.4	2.3
77	15.0	3.3	21.3	2.8	25.4	2.3
76	16.1	3.3	22.2	2.7	26.3	2.3
75	17.4	3.3	23.3	2.7	27.2	2.3
73	19.6	3.3	25.4	2.6	29.0	2.2
70	23.0	3.3	28.2	2.5	31.4	2.1
68	25.3	3.3	30.3	2.4	33.1	2.1
65	28.1	3.0	32.7	2.3	35.3	2.1
63	29.8	2.7	34.7	2.2	36.8	2.0
60	32.1	2.1	36.5	1.8	38.8	1.7
58	33.8	1.8	38.0	1.6	40.1	1.5
55	36.2	1.4	40.0	1.2	42.0	1.2
53	37.7	1.2	41.4	1.1	43.1	1.0
50	39.8	0.9				

ON OUTRIGGERS MID EXTENDED 6.7m SPREAD 360° ROTATION (Unit: x1000kg)						
C	38.3m Boom(telescoping mode I) + 10.1m Jib					
	3.5°Tilt		25°Tilt		45°Tilt	
	R	W	R	W	R	W
80	8.4	6.6	12.5	6.4	14.7	4.9
79	9.3	6.6	13.2	6.2	15.5	4.8
78	10.3	6.6	14.1	6.0	16.2	4.7
77	11.2	6.6	15.0	5.9	17.1	4.7
76	12.2	6.6	15.8	5.7	17.8	4.6
75	13.0	6.6	16.6	5.6	18.6	4.6
73	14.9	6.6	18.2	5.4	20.0	4.5
70	17.4	6.2	20.6	5.1	22.3	4.4
68	19.1	5.9	22.1	4.9	23.7	4.4
65	21.2	4.8	24.0	4.1	25.6	3.8
63	22.6	4.2	25.3	3.6	26.8	3.4
60	24.7	3.4	27.0	2.9	28.5	2.8
58	26.1	2.9	28.3	2.5	29.7	2.4
55	28.0	2.4	30.1	2.1	31.4	2.0
53	29.3	2.0	31.3	1.8	32.5	1.8
50	31.1	1.6	33.0	1.5	34.1	1.4
48	32.3	1.4	34.1	1.3	35.0	1.2
45	34.0	1.1	35.6	1.0	36.4	1.0
43	35.1	0.9				

ON OUTRIGGERS MID EXTENDED 6.7m SPREAD 360° ROTATION (Unit: x1000kg)						
C	38.3m Boom(telescoping mode I) + 17.7m Jib					
	3.5°Tilt		25°Tilt		45°Tilt	
	R	W	R	W	R	W
80	10.5	4.0	17.0	3.2	20.8	2.4
79	11.6	4.0	18.1	3.1	21.7	2.3
78	12.7	4.0	18.9	3.0	22.7	2.3
77	13.7	4.0	19.9	3.0	23.5	2.3
76	14.8	4.0	20.8	2.9	24.4	2.3
75	15.9	4.0	21.8	2.9	25.3	2.3
73	17.8	4.0	23.5	2.8	26.7	2.2
70	20.8	3.8	26.2	2.6	29.3	2.1
68	22.7	3.6	28.0	2.6	30.7	2.1
65	25.6	3.4	30.4	2.5	32.8	2.1
63	27.2	3.0	32.1	2.4	34.4	2.1
60	29.4	2.3	34.0	2.0	36.2	1.9
58	30.9	2.0	35.4	1.7	38.4	1.6
55	33.3	1.6	37.3	1.4	39.1	1.3
53	34.7	1.3	38.5	1.1	40.2	1.1
50	36.8	1.0				

C: Loaded boom angle (°)
R: Load radius(m)
W: Rated lifting capacity(Unit:x1,000kg)

ON OUTRIGGERS

ON OUTRIGGERS MID EXTENDED 5.5m SPREAD																	
360° ROTATION (Unit: x1000kg)																	
B \ A	12.0m		16.4m		20.8m			29.5m			38.3m		42.6m		47.0m		
	C		C		C		C		C		C		C		C		
3.0	70	75.4	75	46.6	79	40.9	78	18.2									
3.5	67	67.0	74	46.6	77	40.9	77	18.2									
4.0	64	60.1	72	46.6	76	40.9	76	18.2									
4.5	61	52.8	70	46.6	75	40.9	74	18.2									
5.0	58	47.2	68	41.1	73	36.5	73	18.2	79	18.2	78	15.1					
5.5	55	40.3	66	35.4	72	31.6	71	18.2	78	18.2	77	15.1					
6.0	52	35.0	64	30.9	70	27.8	70	18.2	77	18.2	76	15.1					
6.5	49	30.1	62	27.3	69	24.6	68	18.2	76	18.2	75	15.1					
7.0	45	25.9	60	24.3	67	22.0	67	18.2	75	18.2	74	15.1	79	15.1	79	13.0	
7.5	42	22.6	58	21.9	66	19.8	65	18.2	74	18.2	74	15.1	78	15.1	78	13.0	
8.0	38	19.9	55	19.4	64	17.9	64	18.2	73	17.4	73	15.1	78	15.1	78	12.8	
9.0	27	15.9	51	15.3	61	14.8	61	16.7	71	14.8	71	15.1	76	14.1	76	12.1	
10.0			46	12.4	57	12.0	57	14.8	69	12.6	69	14.6	75	12.2	75	11.3	
11.0			40	10.2	54	9.8	54	12.5	66	10.9	66	12.8	73	10.7	73	10.7	
12.0			34	8.5	50	8.1	50	10.6	64	9.5	64	11.2	71	9.4	71	10.1	
14.0			13	5.9	42	5.5	42	8.0	60	6.9	59	8.5	68	7.4	68	8.8	
16.0					32	3.8	32	6.2	55	5.1	55	6.7	65	5.7	65	6.9	
18.0					16	2.5	14	4.8	49	3.7	50	5.3	61	4.3	61	5.5	
20.0									44	2.7	44	4.2	57	3.3	58	4.4	
22.0									38	1.9	38	3.4	54	2.5	54	3.6	
24.0									30	1.3	30	2.7	50	1.8	50	2.9	
26.0											20	2.2	45	1.3	45	2.4	
28.0														40	1.9	48	1.5
30.0														35	1.5	44	1.1
32.0														29	1.2		
34.0														20	0.9		
D	0°							35°			0°		29°		38°		

Telescoping conditions(%)

Telescoping Mode	I, II	I	I	II	I	II	I	II	II	I, II
2nd boom	0	50	100	0	100	0	100	0	50	100
3rd boom	0	0	0	33	33	66	66	100	100	100
4th boom	0	0	0	33	33	66	66	100	100	100
Top boom	0	0	0	33	33	66	66	100	100	100

LIFTING CAPACITIES AT ZERO DEGREE BOOM ANGLE ON OUTRIGGERS MID EXTENDED																
5.5m SPREAD 360° ROTATION (Unit: x1000kg)																
C \ A	12.0m		16.4m		20.8m			29.5m			38.3m					
	B		B		B		B		B		B		B		B	
0°	9.8	13.0	14.1	5.8	18.5	2.3	18.3	4.6	27.2	0.5	27.1	2.0			35.4	0.4
Telescoping Mode	I, II		I		I			II			I		II		II	

A: Boom length (m)

B: Load radius (m)

C: Loaded boom angle (°)

D: Minimum boom angle (°) for indicated boom length (no load)

ON OUTRIGGERS

ON OUTRIGGERS MID EXTENDED 5.5m SPREAD 360° ROTATION (Unit: x1000kg)													
C	47.0m Boom + 10.1m Jib						C	47.0m Boom + 17.7m Jib					
	3.5°Tilt		25°Tilt		45°Tilt			3.5°Tilt		25°Tilt		45°Tilt	
	R	W	R	W	R	W		R	W	R	W	R	W
80	10.7	4.9	14.2	4.9	16.8	4.3	80	12.8	3.1	19.3	2.9	23.9	2.3
79	11.9	4.9	15.4	4.7	17.8	4.2	79	14.1	3.1	20.5	2.8	24.9	2.3
78	13.0	4.9	16.5	4.6	18.8	4.1	78	15.6	3.1	21.7	2.7	26.0	2.3
77	14.0	4.9	17.6	4.5	19.8	4.0	77	16.9	3.1	22.9	2.7	27.1	2.3
76	15.2	4.9	18.6	4.4	20.8	3.9	76	18.2	3.1	24.0	2.6	28.2	2.2
75	16.3	4.9	19.5	4.2	21.9	3.9	75	19.5	3.1	23.1	2.6	29.1	2.2
73	18.3	4.2	21.5	3.5	23.6	3.3	73	22.2	2.8	27.5	2.3	31.2	2.2
70	21.2	3.1	24.2	2.7	26.4	2.5	70	25.8	2.0	30.7	1.7	33.9	1.6
68	23.2	2.5	26.1	2.2	28.0	2.1	68	27.9	1.6	32.5	1.4	35.8	1.3
65	26.1	1.8	28.7	1.6	30.5	1.6	65	31.2	1.1	35.4	0.9	38.2	0.9
63	27.8	1.5	30.2	1.3	32.0	1.3							
60	30.1	1.0											

ON OUTRIGGERS MID EXTENDED 5.5m SPREAD 360° ROTATION (Unit: x1000kg)													
C	42.6m Boom(telescoping mode II) + 10.1m Jib						C	42.6m Boom(telescoping mode II) + 17.7m Jib					
	3.5°Tilt		25°Tilt		45°Tilt			3.5°Tilt		25°Tilt		45°Tilt	
	R	W	R	W	R	W		R	W	R	W	R	W
80	9.3	5.3	13.4	5.2	15.7	4.6	80	11.5	3.3	18.6	3.0	22.5	2.4
79	10.4	5.3	14.3	5.1	16.6	4.5	79	12.7	3.3	19.6	2.9	23.5	2.3
78	11.4	5.3	15.2	5.0	17.4	4.4	78	13.9	3.3	20.2	2.8	24.4	2.3
77	12.4	5.3	16.2	4.8	18.3	4.3	77	15.0	3.3	21.2	2.8	25.3	2.3
76	13.6	5.3	17.2	4.7	19.1	4.2	76	16.2	3.3	22.3	2.7	26.3	2.3
75	14.5	5.3	18.1	4.6	20.0	4.1	75	17.5	3.3	23.1	2.7	27.3	2.3
73	16.5	5.2	19.8	4.3	21.6	4.0	73	19.7	3.3	25.9	2.6	29.0	2.2
70	19.2	4.5	22.3	3.9	23.9	3.6	70	23.0	3.2	28.2	2.5	31.5	2.1
68	20.7	3.8	23.8	3.3	25.2	3.1	68	24.7	2.6	29.9	2.3	33.0	2.0
65	23.0	3.0	26.0	2.6	27.2	2.4	65	27.4	2.0	32.4	1.8	35.0	1.5
63	24.5	2.5	27.3	2.2	28.5	2.1	63	29.1	1.7	33.8	1.5	36.4	1.3
60	26.7	1.9	29.5	1.7	30.5	1.6	60	31.6	1.3	36.0	1.1	38.5	1.0
58	28.1	1.6	30.8	1.5	31.8	1.4	58	33.2	1.0				
55	30.3	1.2	32.8	1.1	33.7	1.1							
53	31.7	1.0											

ON OUTRIGGERS MID EXTENDED 5.5m SPREAD 360° ROTATION (Unit: x1000kg)													
C	38.3m Boom(telescoping mode I) + 10.1m Jib						C	38.3m Boom(telescoping mode I) + 17.7m Jib					
	3.5°Tilt		25°Tilt		45°Tilt			3.5°Tilt		25°Tilt		45°Tilt	
	R	W	R	W	R	W		R	W	R	W	R	W
80	8.4	6.6	12.5	6.4	14.7	4.9	80	10.5	4.0	17.0	3.2	20.8	2.4
79	9.3	6.6	13.4	6.2	15.5	4.8	79	11.6	4.0	18.1	3.1	21.7	2.3
78	10.3	6.6	14.2	6.0	16.3	4.7	78	12.7	4.0	19.0	3.0	22.7	2.3
77	11.2	6.6	15.0	5.9	17.1	4.7	77	13.8	4.0	19.9	3.0	23.6	2.3
76	12.2	6.6	15.9	5.7	17.9	4.6	76	14.8	4.0	20.8	2.9	24.5	2.3
75	13.0	6.6	16.6	5.6	18.7	4.6	75	15.9	4.0	21.8	2.9	25.3	2.3
73	14.8	6.3	18.3	5.4	20.1	4.5	73	18.0	4.0	23.6	2.8	26.9	2.2
70	17.1	5.0	20.3	4.3	22.2	3.9	70	20.7	3.7	26.3	2.6	29.2	2.1
68	18.6	4.2	21.7	3.7	23.4	3.4	68	22.5	3.1	28.0	2.5	30.8	2.1
65	20.8	3.3	23.6	2.9	25.3	2.7	65	25.0	2.4	30.1	1.9	32.8	1.8
63	22.3	2.8	24.9	2.5	26.5	2.3	63	26.6	1.9	31.5	1.6	34.0	1.5
60	24.4	2.1	26.8	1.9	28.3	1.8	60	28.9	1.4	33.7	1.2	35.9	1.1
58	25.8	1.8	28.1	1.6	29.5	1.5	58	30.5	1.1	35.1	1.0	37.1	0.9
55	27.8	1.3	29.9	1.2	31.3	1.1							
53	28.9	1.0	31.0	1.0	32.3	0.9							

C: Loaded boom angle (°)
R: Load radius(m)
W: Rated lifting capacity(Unit:x1,000kg)

ON OUTRIGGERS

ON OUTRIGGERS MIN EXTENDED 2.7m SPREAD 360° ROTATION (Unit: x1000kg)																				
B	A	12.0m		16.4m		20.8m		29.5m		38.3m		42.6m	47.0m							
	C	C	C	C	C	C	C	C	C	C	C	C	C							
3.0	70	33.8	75	28.9	79	20.9	78	18.2												
3.5	67	27.7	74	23.9	78	20.9	77	18.2												
4.0	64	23.3	71	20.2	76	17.8	75	18.2												
4.5	61	19.9	70	17.3	75	15.3	74	18.2												
5.0	58	17.2	68	15.0	73	13.2	73	16.1	78	12.7	78	14.6								
5.5	55	14.5	66	13.0	72	11.5	71	14.4	77	11.3	77	13.1								
6.0	52	12.3	64	11.5	70	10.1	70	12.9	76	10.1	76	11.9								
6.5	48	10.6	62	10.1	68	8.9	68	11.6	75	9.0	75	10.8								
7.0	45	9.2	60	8.7	67	7.8	67	10.5	74	8.1	74	9.9	78	7.8	79	8.5				
7.5	42	8.0	57	7.5	66	6.9	65	9.6	73	7.3	73	9.1	77	7.1	78	8.5				
8.0	38	7.0	55	6.5	64	6.1	63	8.7	72	6.6	72	8.3	77	6.5	77	7.8				
9.0	28	5.4	50	4.9	61	4.6	60	7.0	70	5.4	70	7.1	75	5.4	76	6.7	77	5.9	78	4.4
10.0			46	3.7	57	3.3	57	5.7	68	4.4	68	6.1	74	4.5	74	5.8	76	5.1	78	4.4
11.0			40	2.7	54	2.3	53	4.6	66	3.6	66	5.1	72	3.8	72	5.0	74	4.4	76	3.6
12.0			34	1.9	50	1.5	49	3.8	63	2.8	63	4.3	71	3.1	71	4.4	73	3.6	75	2.9
14.0							41	2.5	59	1.6	59	3.0	67	2.0	68	3.2	70	2.5	72	1.9
16.0							32	1.6			54	2.1	64	1.1	64	2.3	67	1.7	69	1.1
18.0							12	0.9			49	1.4			61	1.6	64	1.0		
20.0													57	1.0						
D		0°		12°		42°		0°	54°	43°		60°	53°		58°		63°			

Telescoping conditions(%)

Telescoping Mode	I, II	I	I	II	I	II	I	II	II	II	I, II
2nd boom	0	50	100	0	100	0	100	0	50	100	
3rd boom	0	0	0	33	33	66	66	100	100	100	
4th boom	0	0	0	33	33	66	66	100	100	100	
Top boom	0	0	0	33	33	66	66	100	100	100	

LIFTING CAPACITIES AT ZERO DEGREE BOOM ANGLE ON OUTRIGGERS MIN EXTENDED 2.7m SPREAD 360° ROTATION (Unit: x1000kg)												
C	A	12.0m		20.8m		29.5m		38.3m		47.0m		
	B	B	B	B	B	B	B	B	B	B	B	
0°	9.8	4.0			18.3	0.8						
Telescoping Mode		I, II			II							

- A: Boom length (m)
- B: Load radius (m)
- C: Loaded boom angle (°)
- D: Minimum boom angle (°) for indicated boom length (no load)

NOTES FOR "ON OUTRIGGERS" TABLE

- Rated lifting capacities shown in the table are based on condition that crane is set on firm level surface. Those above thick lines are based on crane strength and those below, on its stability.
- Rated lifting capacities based on crane stability are according to ISO4305.
- Rated lifting capacities shown in the table are based on condition that crane is set on firm level surface. Those above thick lines are based on crane strength and those below, on its stability.
- The mass of the hook (800 kg for 90.7 t capacity, 540 kg for 60 t capacity, 450 kg for 35 t capacity, 165 kg for 6.6 t capacity), slings and all similarly used load handling devices must be considered as part of the load and must be deducted from the lifting capacities.
- For rated lifting capacity of single top, reduce the rated lifting capacities of relevant boom according to a weight reduction for auxiliary load handling equipment. Capacities of single top shall not exceed 6,600 kg including main boom hook mass and the net capacity must be so reduced.
- Standard number of parts of line for each boom length is as shown below. Load per line should not surpass 64.7 kN {6,600 kgf} for main winch and auxiliary winch.

Boom length	12.0m	12.0m to 20.8m	20.8m to 47.0m	Single top Jib
Telescoping mode	I, II	I	II	I, II
Number of parts of line	14	8	4	1

The lifting capacity data stored in the Automatic Moment Limiter (AML) is based on the standard number of parts of line listed in the chart.

Maximum lifting capacity is restricted by the number of parts of line of Automatic Moment Limiter (AML).

- The lifting capacity for over-side area differs depending on the outrigger extension width. Work with the capacity corresponding to the extension width. The lifting capacities for over-front and over-rear areas are for "outriggers fully extended". However, the areas (angle a) differ depending on the outrigger extension width.

Outriggers extended width	6.7m(middle)	5.5m(middle)	2.7m(minimum)
Angle a°	60	40	10

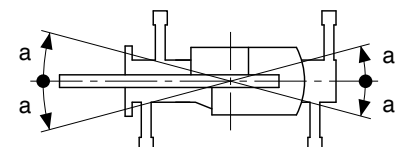

ON RUBBER (ON TIRES)

ON RUBBER STATIONARY (Unit: x1000kg)												
B	A	Over Front						360° Rotation				
		12.0m		20.8m		29.5m		12.0m		20.8m		29.5m
		C		C		C		C		C		C
3.5	67	28.5										
4.0	64	25.3					64	15.5				
4.5	61	23.0					61	12.9				
5.0	58	20.9					58	10.9				
5.5	55	19.0					55	9.3				
6.0	52	17.3	70	13.5			52	7.9	70	9.0		
6.5	49	15.9	68	13.5			49	6.6	68	7.8		
7.0	45	14.7	67	13.5	74	10.4	45	5.6	67	6.8		
7.5	42	13.3	65	13.5	73	10.4	42	4.7	65	6.0	73	6.8
8.0	38	12.2	63	12.6	72	10.4	38	3.8	63	5.2	72	6.0
8.5	33	11.0	62	11.7	71	10.0	33	3.3	62	4.7	71	5.2
9.0	28	10.0	60	10.8	70	9.8	28	2.8	60	4.2	70	4.6
10.0			57	9.0	68	9.3			57	3.3	68	3.5
11.0			53	7.6	66	8.3			53	2.5	66	2.8
12.0			50	6.5	64	7.2			50	2.0	63	2.2
14.0			42	4.8	59	5.3			42	1.0	59	1.5
16.0			32	3.5	54	4.1						
18.0			13	2.5	49	3.2						
20.0					44	2.5						
22.0					37	1.8						
24.0					30	1.2						
26.0					19	0.9						
D										31°		54°

Telescoping conditions(%)

Telescoping Mode	I, II	II	II	I, II	II	II
2nd boom	0	0	0	0	0	0
3rd boom	0	33	66	0	33	66
4th boom	0	33	66	0	33	66
Top boom	0	33	66	0	33	66

LIFTING CAPACITIES AT ZERO DEGREE BOOM ANGLE ON RUBBER STATIONARY												
C	A	Over Front						360° Rotation				
		12.0m		20.8m		29.5m		12.0m				
		B		B		B		B				
0		9.9	8.5	18.3	2.4	27.2	0.6	9.9	2.0			

ON RUBBER CREEP (Unit: x1000kg)												
B	A	Over Front						360° Rotation				
		12.0m		20.8m		29.5m		12.0m		20.8m		29.5m
		C		C		C		C		C		C
4.0	65	19.0					64	11.2				
4.5	61	17.0					62	9.8				
5.0	58	15.1					58	8.5				
5.5	55	13.6					55	7.5				
6.0	52	12.4	70	13.5			52	6.5	69	7.5		
6.5	49	11.4	68	12.3			49	5.4	68	6.5		
7.0	45	10.3	66	11.4	74	10.4	45	4.7	67	5.8		
7.5	42	9.5	65	10.5	73	10.4	42	3.8	65	5.0	73	5.8
8.0	39	8.7	64	9.7	72	10.0	38	3.1	63	4.3	72	5.0
8.5	33	8.0	62	9.1	71	9.4	34	2.5	62	3.8	71	4.3
9.0	27	7.3	60	8.5	70	8.7	28	2.3	60	3.3	70	3.8
10.0			57	7.3	68	7.7			57	2.5	69	3.0
11.0			53	6.3	66	6.7			53	2.0	68	2.5
12.0			50	5.6	64	6.0			50	1.5	66	1.9
14.0			42	4.2	59	4.7					59	1.1
16.0			32	3.3	54	3.7						
18.0			13	2.5	49	2.6						
20.0					43	2.0						
22.0					37	1.4						
24.0					30	1.0						
D										38°		54°

Telescoping conditions(%)

Telescoping Mode	I, II	II	II	I, II	II	II
2nd boom	0	0	0	0	0	0
3rd boom	0	33	66	0	33	66
4th boom	0	33	66	0	33	66
Top boom	0	33	66	0	33	66

LIFTING CAPACITIES AT ZERO DEGREE BOOM ANGLE ON RUBBER STATIONARY												
C	A	Over Front						360° Rotation				
		12.0m		20.8m				12.0m				
		B		B				B				
0		9.9	6.3	18.3	2.4			9.9	1.6			

- A: Boom length (m)
- B: Load radius (m)
- C: Loaded boom angle (°)
- D: Minimum boom angle (°) for indicated boom length (no load)

NOTES FOR "ON RUBBER" TABLES

1. Rated lifting capacities shown in the table are based on condition that crane is set on firm level surface, with suspension lock applied. Those above thick lines are based on tire capacity and those below, on crane stability. They are based on actual load radius increased by tire deformation and boom deflection.
2. Rated lifting capacities based on crane stability are according to ISO4305.
3. The mass of the hook (700 kg for 80t capacity, 500 kg for 50t capacity, 450 kg for 35t capacity, 165 kg for 6.6t capacity), slings and all similarly used load handling devices must be considered as part of the load and must be deducted from the lifting capacities.
4. For rated lifting capacity of single top, reduce the rated lifting capacities of relevant boom according to weight reductions for auxiliary load handling equipment. Capacities of single top shall not exceed 6,600 kg including main hook.
5. On rubber lifting with "jib" is not permitted. Maximum permissible boom length is 29.5 m.
6. CREEP is motion for crane not to travel more than 60 m in any 30 minute period and to travel at the speed of less than 1.6 km/h.
7. During "CREEP" duties travel slowly and keep the lifting load as close to the ground as possible, and especially avoid any abrupt steering, accelerating or braking.
8. Do not operate the crane while carrying the load.
9. Tires should be inflated to their correct air pressure of 400kPa.
10. For CREEP operation, choose the drive mode and proper gear according to the road or working condition.
11. Standard number of parts of line for on rubber operation should be according to the following table.
Load per line should not surpass 64.7 kN {6,600 kgf} for main winch and auxiliary winch.

Boom length	12.0m	12.0m to 29.5m	Single top
Telescoping mode	I, II	II	I, II
Number of parts of line	6	4	1

The lifting capacity data stored in the Automatic Moment Limiter (AML) is based on the standard number of parts of line listed in the chart.

Maximum lifting capacity is restricted by the number of parts of line of Automatic Moment Limiter (AML).

WORKING AREA

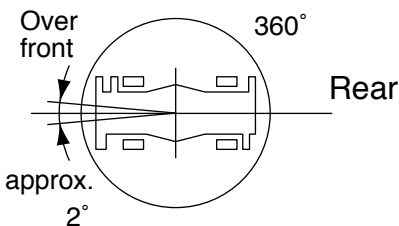

Without outriggers "Over front" operation should be performed within 2 degrees in front of chassis.

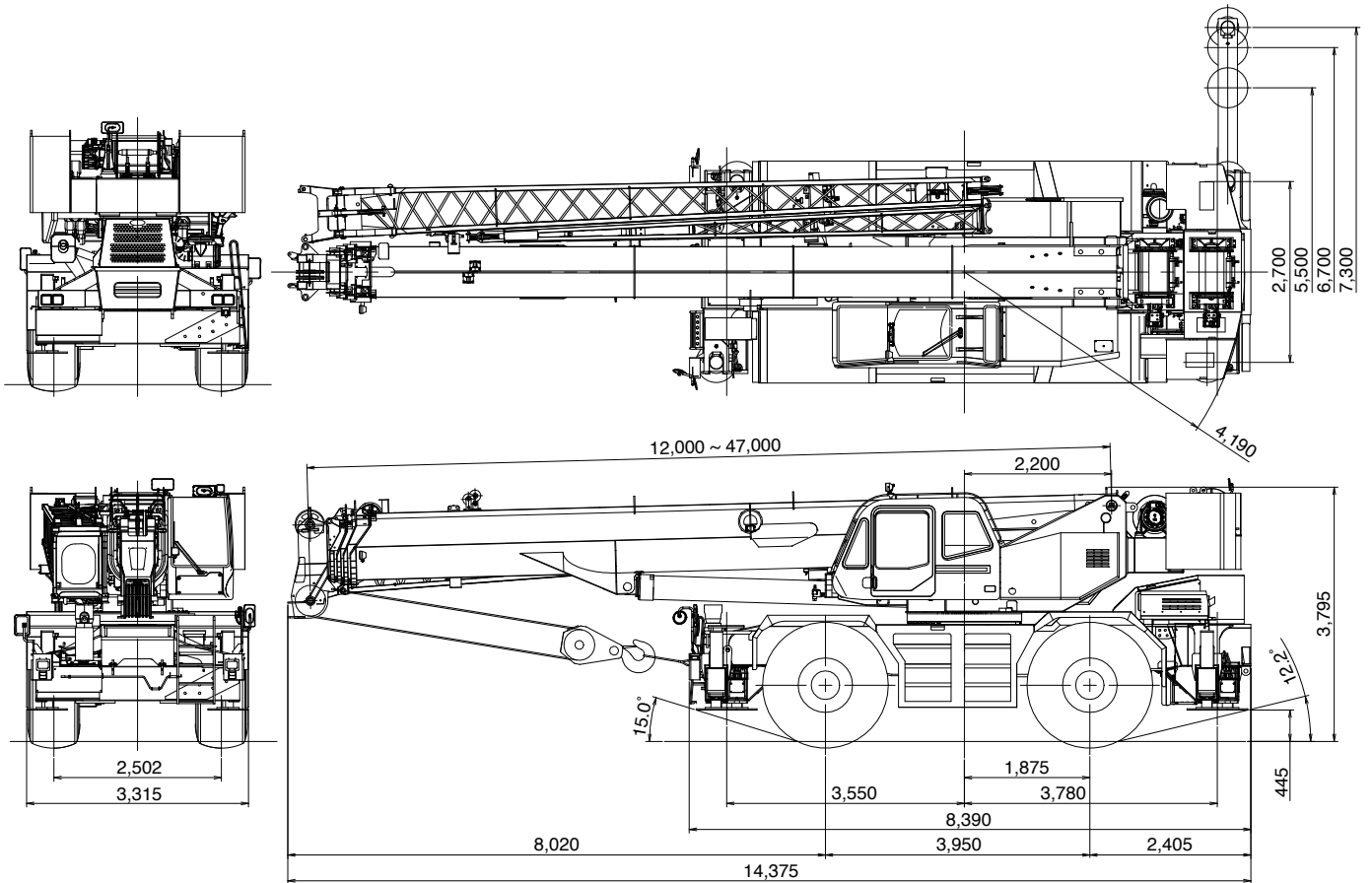

Note: Dimension is with boom angle at -1.5 degree.

Axle Weight Distribution Chart

Unit : kg

	GVW	Front	Rear
Basic standard machine includes: 5-section boom (12.0 m - 47.0 m) 2-stage jib (10.1 m, 17.7 m) Mitsubishi 6M60-TL 29.5-25 34PR tires Single top 6.6 ton hook block	51,410	24,325	27,085
Add:			
1. 80t 7 sheaves hook block	+700	+1,350	-650
2. 50t 5 sheaves hook block	+500	+960	-460
3. 35t 3 sheaves hook block	+450	+870	-420
Remove:			
1. 6.6 ton hook block	-165	-235	+70
2. Top jib	-335	-450	+115
3. Base jib	-865	-1,705	+840
4. Counter weight with auxiliary winch and wire rope	-9,980	+4,240	-14,220

Specifications are subject to change without notice.



TADANO

TADANO LTD. (International Division)

4-12, Kamezawa 2-chome,
Sumida-ku, Tokyo 130-0014, Japan

Tel : 81-(0)3-3621-7750

Fax : 81-(0)3-3621-7785

 <http://www.tadano.co.jp/indexe.htm>

 tdnihq@tadano.co.jp

Printed in Japan

GR-800EX-2012-06-2